

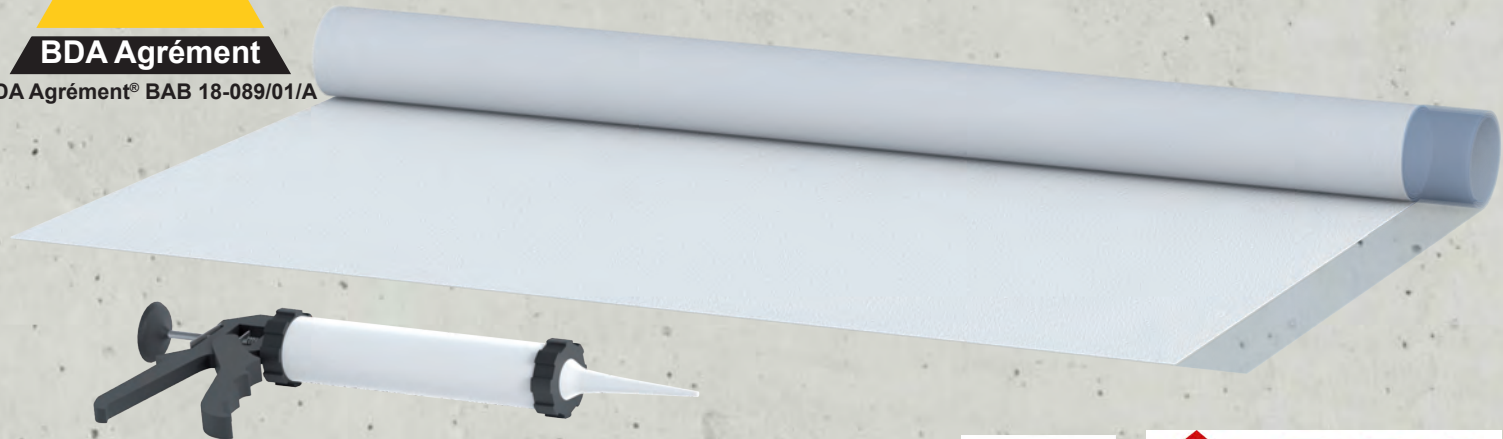

DualProof FBVF pre-applied waterproofing membrane

BDA Agrément

BDA Agrément® BAB 18-089/01/A



CEMproof® DualProof

DualProof – Durable and watertight solution for below grade concrete structures

DualProof

DualProof is a fully and permanently bonded, self-adhesive, composite sheet membrane waterproofing system. It consists of a highly flexible PVC membrane laminated with a non-woven PP-fleece. DualProof is cold-applied and pre-applied, as it is installed without heat or open-flames, and before the steel reinforcement is fixed and the concrete is poured.

Field of Application

General Applications of DualProof

Damp-proofing against:

- Rising humidity through capillary action
- Percolating water, for slab-on-ground foundations, column footings, strip foundations, and walls
- diffusion, effusion, sorption

Concrete protection against:

- Various gases of the ground (Radon Test)
- Different types of chemicals in solution (sulphate, chloride, carbonate, hydrogen carbonate, etc.)
- Contaminated ground water

Waterproofing Resistant to:

- Water under hydrostatic pressure
- Lateral water migration for deep, one or multi-level below grade structures.
- According to the German DIN 18195 and DIN 18533 "pressurized water"
- Additional sealing membrane to all watertight concrete structures

DualProof is an innovative system "Made in Germany" that prevents any lateral water and migration between the waterproofing membrane and the structural concrete.

The secret of the high durable watertight solution called CEMproof DualProof is the combination of a special designed non-woven (**The new PP FiberTex technology**) and a highly flexible PVC-membrane.

The manufacturing process is the secret which creates "absolutely watertight bonding with the fresh concrete". This self-adhesive bonding blocks any lateral water migration, even in the event of any local damage to the membrane. The DualProof membrane itself is also connected together with the special designed fleece, that any water circulation in the fleece itself is absolutely impossible.

This fleece is also embedded completely into the fresh concrete and creates a full and durable mechanical

bond between the PVC membrane layer of DualProof and the cured concrete.

CEMproof DualProof can be used in saltwater areas in order to protect the concrete structure!

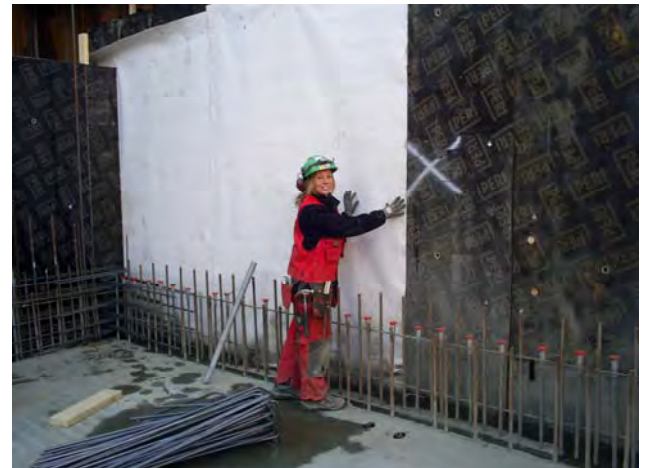

Areas of Use

CEMproof DualProof is used in all applications, where structures have to be protected against groundwater and seepage.

For the waterproofing of foundations, basements, tunnels, garages and all other concrete constructions below grade. CEMproof DualProof is an economically and environmentally friendly alternative to bituminous products and coatings.

Advantages of DualProof

- Tough and resistant, quick and easy to install, high compound shear strength
- Can be installed in every season, independently of temperature and weather condition
- No use of complicated welding equipment and specially trained staff, overlapping can be easily secured with CEM 805 adhesive
- Quality control (CE-Certification)
- Self-adhesive bonding properties of the system
- Seals small cracks in the concrete
- Suitable roll dimensions (1 x 25m = 25 m²)
- Can be used in saltwater condition
- Several tests have been made at the University of Braunschweig/Germany
- Easy handling of CEMproof DualProof

Technical Data Sheet

- DualProof T 1,2 - 1,2 mm PVC transparent + PP-FiberTex
- DualProof T 2,0 - 2,0 mm PVC transparent + PP-FiberTex
- DualProof S 1,2 - 1,2 mm PVC transparent + PP-swell/active
- DualProof S 2,0 - 2,0 mm PVC transparent + PP-swell/active



Technical Information March 2017



Storage

CEMproof DualProof has to be stored dry and frost-free. DualProof has to be protected during storage against UV. Shelf life is 5 years.



Form of Delivery

Dimension: 1,20 x 25 m (*2,6m x 25m) (A) (A) (A)
 Types: DualProof T 1,0 / 1,2 / 2,0 DualProof S 1,0 / 1,2 / 2,0
 Weight per sqm: 2,5 / 3,0 / 4,0 / 5,0 / 6,0 / 7,0 / 8,0 / 9,0 / 10,0 / 11,0 / 12,0 / 13,0 / 14,0 / 15,0 / 16,0 / 17,0 / 18,0 / 19,0 / 20,0 / 21,0 / 22,0 / 23,0 / 24,0 / 25,0 / 26,0 / 27,0 / 28,0 / 29,0 / 30,0 / 31,0 / 32,0 / 33,0 / 34,0 / 35,0 / 36,0 / 37,0 / 38,0 / 39,0 / 40,0 / 41,0 / 42,0 / 43,0 / 44,0 / 45,0 / 46,0 / 47,0 / 48,0 / 49,0 / 50,0 / 51,0 / 52,0 / 53,0 / 54,0 / 55,0 / 56,0 / 57,0 / 58,0 / 59,0 / 60,0 / 61,0 / 62,0 / 63,0 / 64,0 / 65,0 / 66,0 / 67,0 / 68,0 / 69,0 / 70,0 / 71,0 / 72,0 / 73,0 / 74,0 / 75,0 / 76,0 / 77,0 / 78,0 / 79,0 / 80,0 / 81,0 / 82,0 / 83,0 / 84,0 / 85,0 / 86,0 / 87,0 / 88,0 / 89,0 / 90,0 / 91,0 / 92,0 / 93,0 / 94,0 / 95,0 / 96,0 / 97,0 / 98,0 / 99,0 / 100,0
 Total-Thickness: 1,0 / 1,2 / 1,5 / 2,0 / 2,5 / 3,0 / 3,5 / 4,0 / 4,5 / 5,0 / 5,5 / 6,0 / 6,5 / 7,0 / 7,5 / 8,0 / 8,5 / 9,0 / 9,5 / 10,0 / 10,5 / 11,0 / 11,5 / 12,0 / 12,5 / 13,0 / 13,5 / 14,0 / 14,5 / 15,0 / 15,5 / 16,0 / 16,5 / 17,0 / 17,5 / 18,0 / 18,5 / 19,0 / 19,5 / 20,0 / 20,5 / 21,0 / 21,5 / 22,0 / 22,5 / 23,0 / 23,5 / 24,0 / 24,5 / 25,0 / 25,5 / 26,0 / 26,5 / 27,0 / 27,5 / 28,0 / 28,5 / 29,0 / 29,5 / 30,0 / 30,5 / 31,0 / 31,5 / 32,0 / 32,5 / 33,0 / 33,5 / 34,0 / 34,5 / 35,0 / 35,5 / 36,0 / 36,5 / 37,0 / 37,5 / 38,0 / 38,5 / 39,0 / 39,5 / 40,0 / 40,5 / 41,0 / 41,5 / 42,0 / 42,5 / 43,0 / 43,5 / 44,0 / 44,5 / 45,0 / 45,5 / 46,0 / 46,5 / 47,0 / 47,5 / 48,0 / 48,5 / 49,0 / 49,5 / 50,0 / 50,5 / 51,0 / 51,5 / 52,0 / 52,5 / 53,0 / 53,5 / 54,0 / 54,5 / 55,0 / 55,5 / 56,0 / 56,5 / 57,0 / 57,5 / 58,0 / 58,5 / 59,0 / 59,5 / 60,0 / 60,5 / 61,0 / 61,5 / 62,0 / 62,5 / 63,0 / 63,5 / 64,0 / 64,5 / 65,0 / 65,5 / 66,0 / 66,5 / 67,0 / 67,5 / 68,0 / 68,5 / 69,0 / 69,5 / 70,0 / 70,5 / 71,0 / 71,5 / 72,0 / 72,5 / 73,0 / 73,5 / 74,0 / 74,5 / 75,0 / 75,5 / 76,0 / 76,5 / 77,0 / 77,5 / 78,0 / 78,5 / 79,0 / 79,5 / 80,0 / 80,5 / 81,0 / 81,5 / 82,0 / 82,5 / 83,0 / 83,5 / 84,0 / 84,5 / 85,0 / 85,5 / 86,0 / 86,5 / 87,0 / 87,5 / 88,0 / 88,5 / 89,0 / 89,5 / 90,0 / 90,5 / 91,0 / 91,5 / 92,0 / 92,5 / 93,0 / 93,5 / 94,0 / 94,5 / 95,0 / 95,5 / 96,0 / 96,5 / 97,0 / 97,5 / 98,0 / 98,5 / 99,0 / 99,5 / 100,0
 PVC d a ·] æ ^ } ç 200g/m² · ^ | | ç * A ^ & A ; / F E E * Q Á Ú Ú Á &
 The **new PP FiberTex Technology** gives the DualProof its unique bond and connection to the concrete.



Pictures / Application of the system

CE-marked according DIN EN 13967 - DIN 20000-202 SPEC // DualProof T - pre-applied waterproofing membrane
 DualProof S - post-applied waterproofing membrane with swelling, self-healing behaviour
 DualProof is a public-tested and approved Waterproofing Technology

DualProof - pre-applied waterproofing membrane
 CE-marked according to DIN EN 13967
 Fulfills DIN 20000-202 SPEC German Standards
 Fulfills BS 8102:2009 British Standards

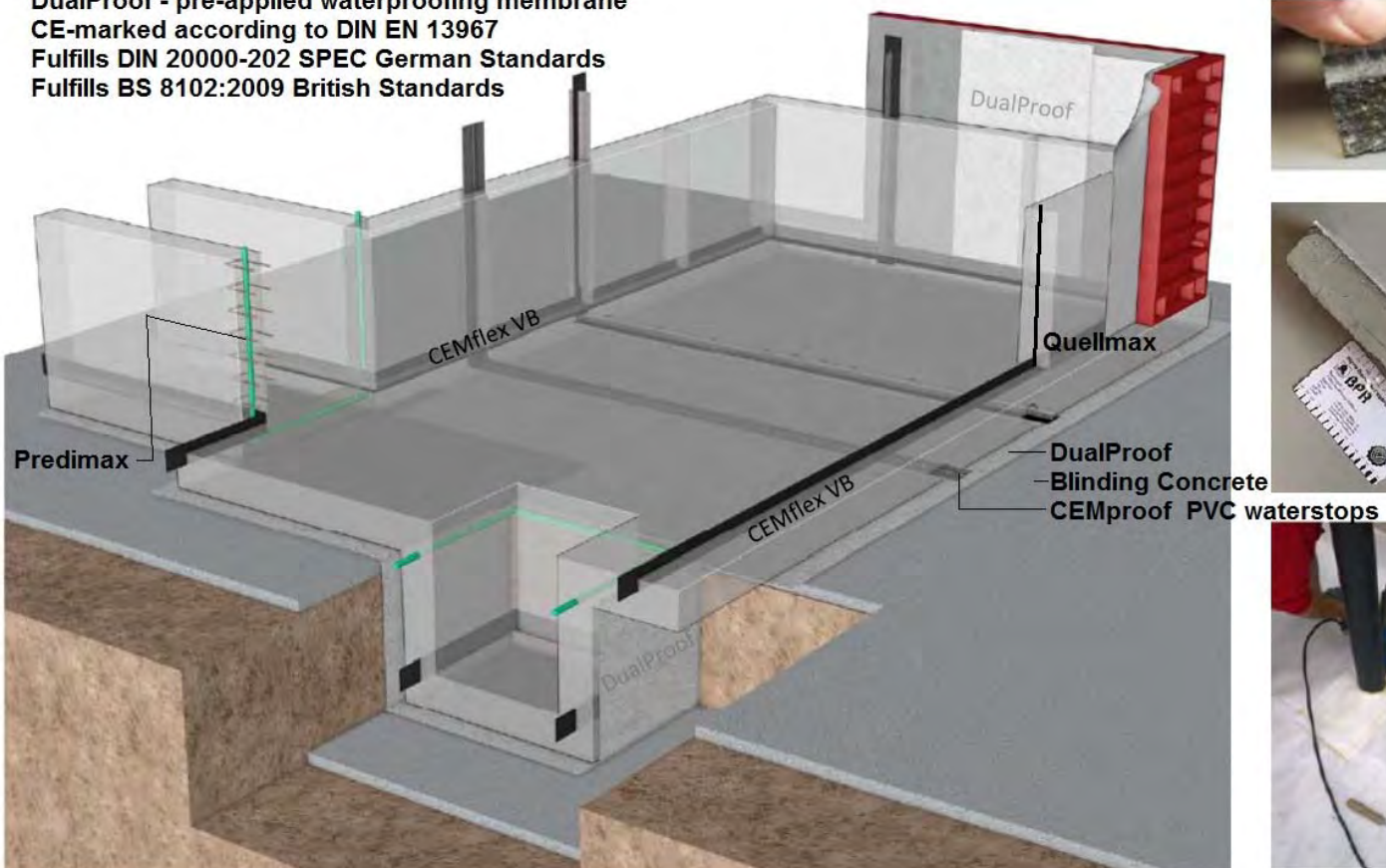

British Standard 8102 : 2009

BS8102:2009 'Code of Practice for Protection of Below Ground Structures Against Water From the Ground'.

Type of waterproofing:

Type A (Barrier) protection - A barrier to water ingress is applied to the inner or outer surface of the structure. (Membranes / coatings)

CEMproof® DualProof - unique mechanical bond to the concrete



Type B (Structurally Integral) protection - The structure is formed as a watertight construction using admixtures and water-bars.

CEMflex VB - unique mechanical bond to the concrete and active crystallisation sealing

Type C (Drained) protection - Water entering the structure is received by planned cavities or voids and safely removed using sump and pumps.

CEMdrain - highly pressure resistant drainage board

Grades of waterproofing protection:

Grade 1 - Some water seepage and damp is tolerable depending on the intended use. Car parking, plant rooms (No electrical equipment) etc. local drainage may be provided.

Capillary moistened -watertight concrete structures!

Grade 2 - No water penetration is acceptable. Damp areas are tolerable depending on the end use. Plant rooms, workshops etc.

Mainly dry -watertight concrete structure **including** accessories to seal joints, formwork ties, penetrations, additional reinforcement, crack reduction reinforcement, concrete admixture, advanced concrete technology, etc.! Fully designed and detailed concrete structure by a waterproofing specialist / engineer!

Grade 3 - No dampness or water penetration is acceptable - Ventilated residential and commercial areas such as homes, offices, shops etc.

Completely dry -watertight concrete structure and additional sealing membrane! **DualProof** is especially designed and developed to seal concrete structures against pressurized water. The inner surface of the finishes and services work must be sufficiently impervious so that no area of moisture can be detected on the inner surface.



Dual Proof – concrete sealing membrane

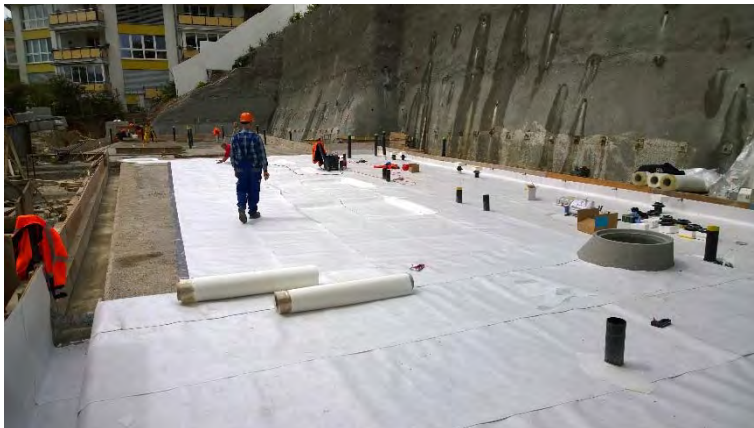
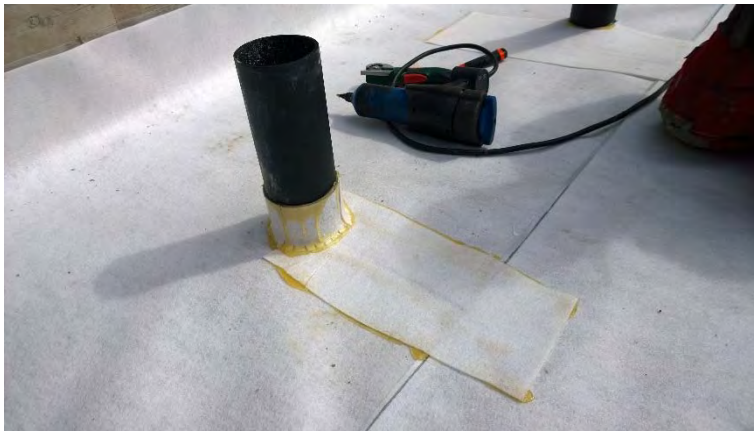

DualProof pre-applied waterproofing membrane Installation Guideline

DualProof T 1,2mm - pre-applied waterproofing membrane
DualProof T 2,0mm - pre-applied waterproofing membrane

DualProof S 1,2mm - post-applied waterproofing membrane s - swelling, self-healing
DualProof S 2,0mm - post-applied waterproofing membrane s - swelling, self-healing

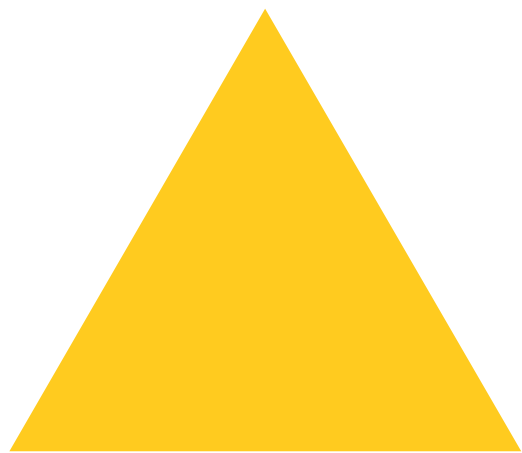
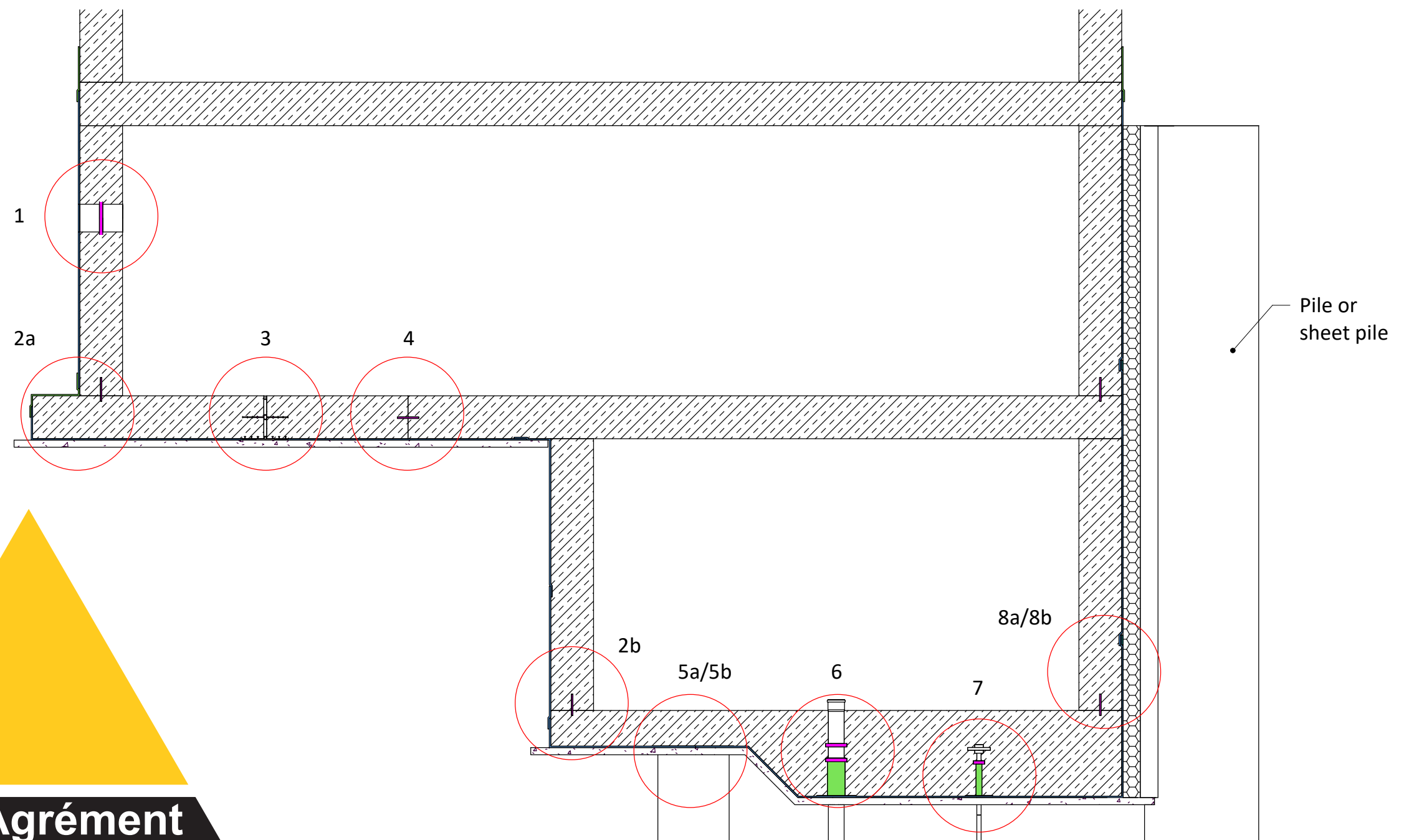

BDA Agrément

BDA Agrément® BAB 18-089/01/A

DualProof pre-applied waterproofing membrane Installation Guidline

DualProof T 1,2mm - pre-applied waterproofing membrane
DualProof T 2,0mm - pre-applied waterproofing membrane

DualProof S 1,2mm - post-applied waterproofing membrane s - swelling, self-healing
DualProof S 2,0mm - post-applied waterproofing membrane s - swelling, self-healing

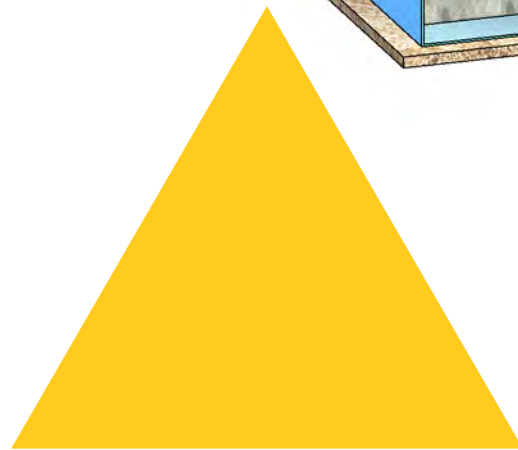
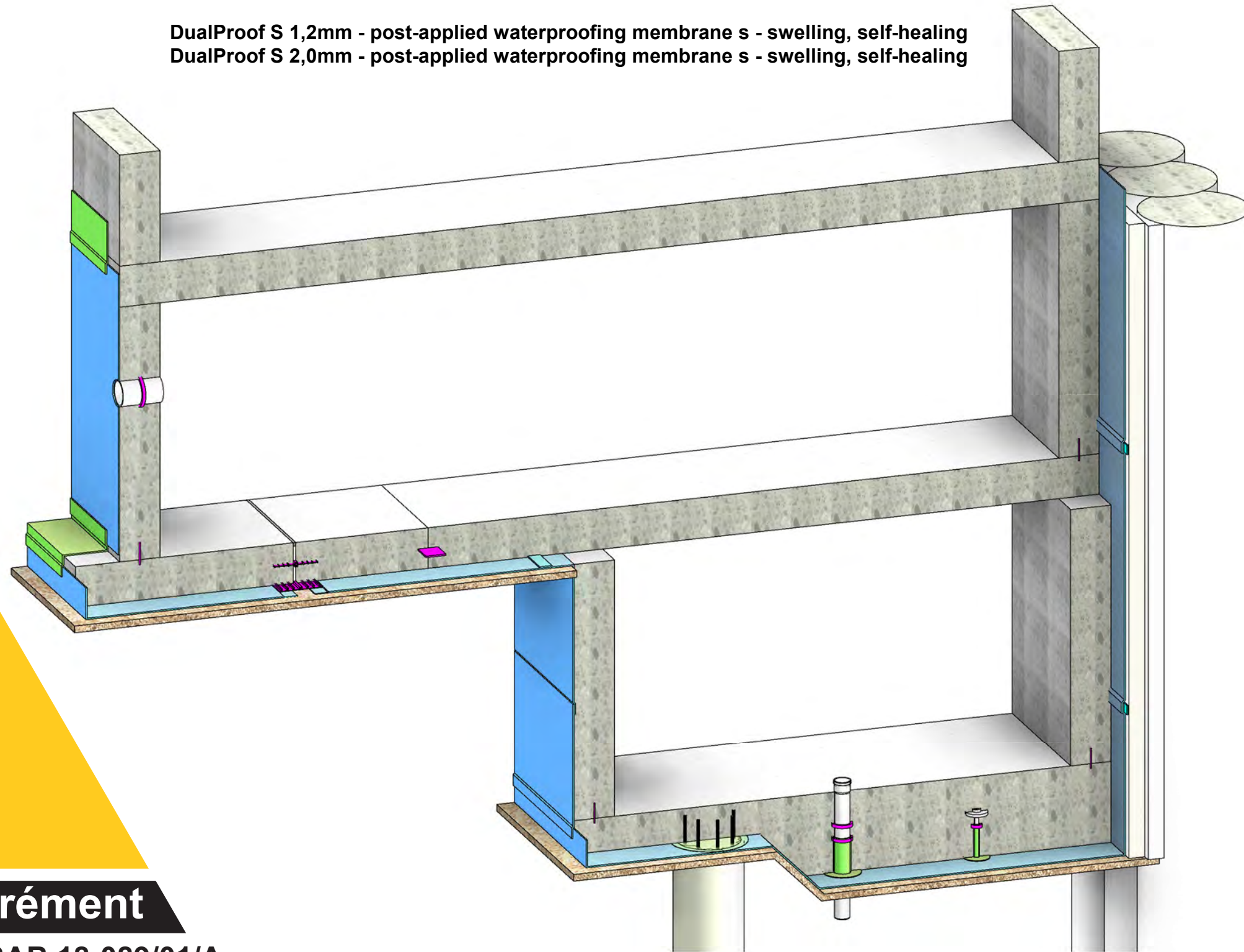

BDA Agrément

BDA Agrément® BAB 18-089/01/A

DualProof pre-applied waterproofing membrane Installation Guidline

DualProof T 1,2mm - pre-applied waterproofing membrane
DualProof T 2,0mm - pre-applied waterproofing membrane

DualProof S 1,2mm - post-applied waterproofing membrane s - swelling, self-healing
DualProof S 2,0mm - post-applied waterproofing membrane s - swelling, self-healing

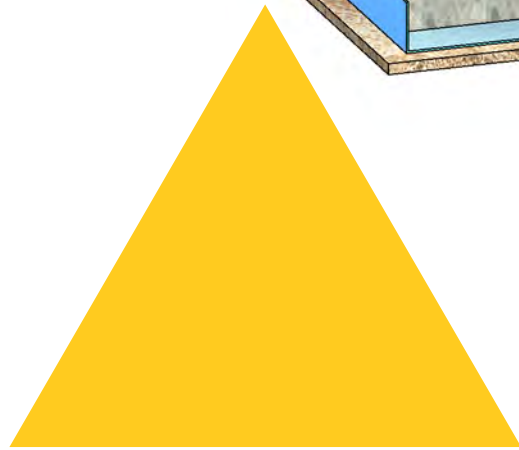
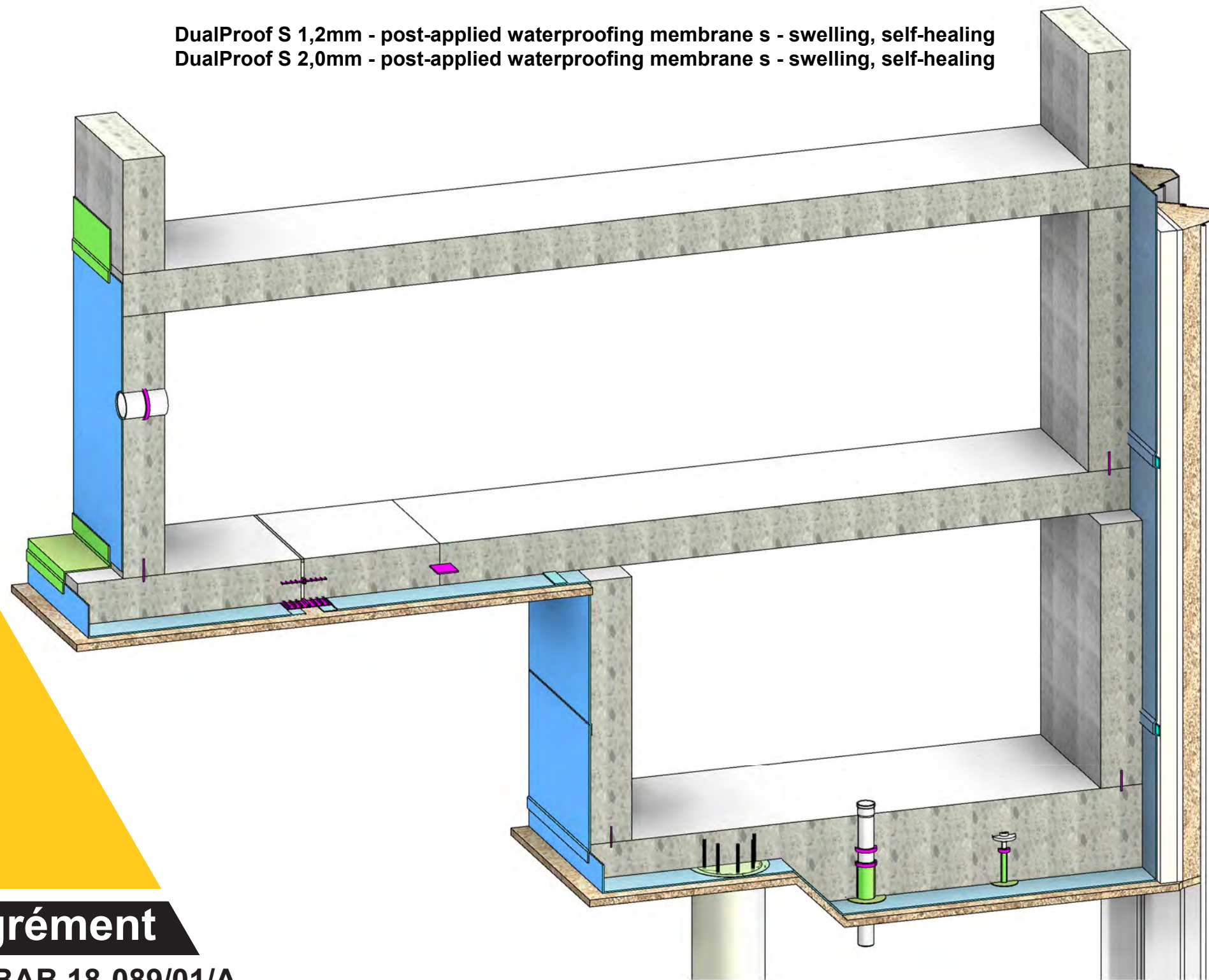

BDA Agrément

BDA Agrément® BAB 18-089/01/A

1 Pipe Penetration

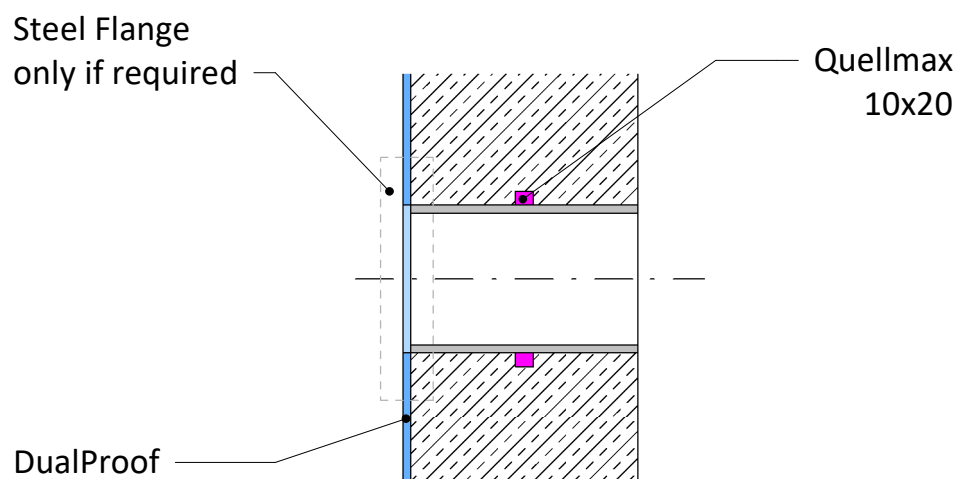
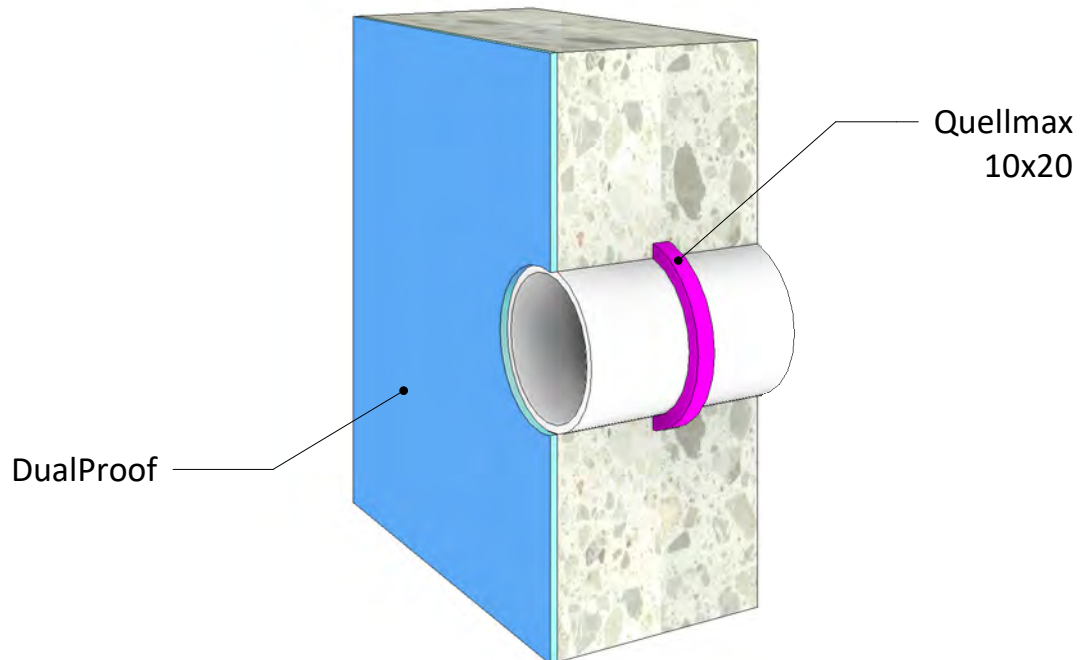

Project:

Title: 1 Pipe Penetration

Clients:

Date:

Drawing by TE

BPA © 02/2018

2a Floor Slab / wall

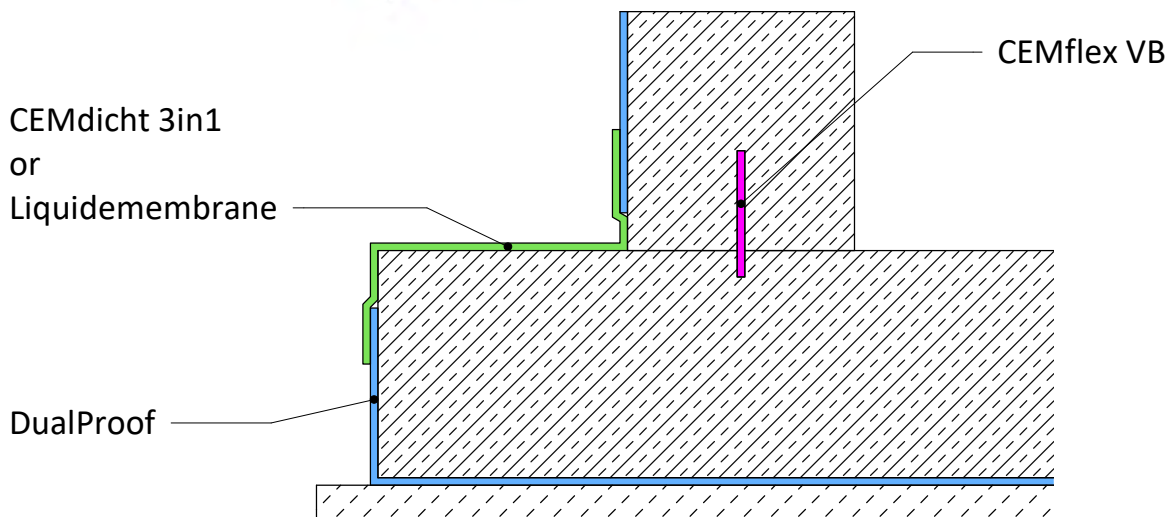
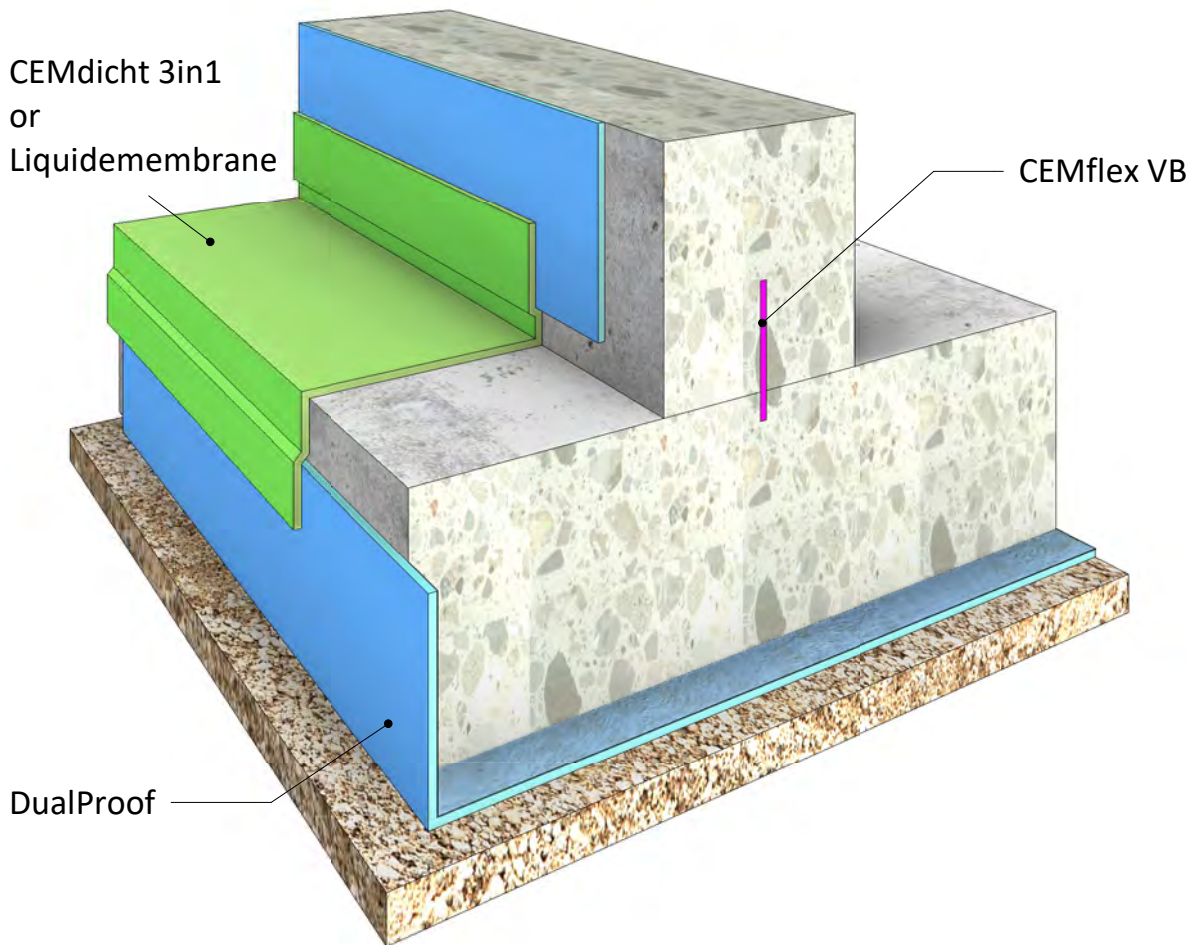

Project:

Title: 2a Floor Slab / wall

Clients:

Date:

Drawing by TE

BPA © 02/2018

2b Floor Slab / wall

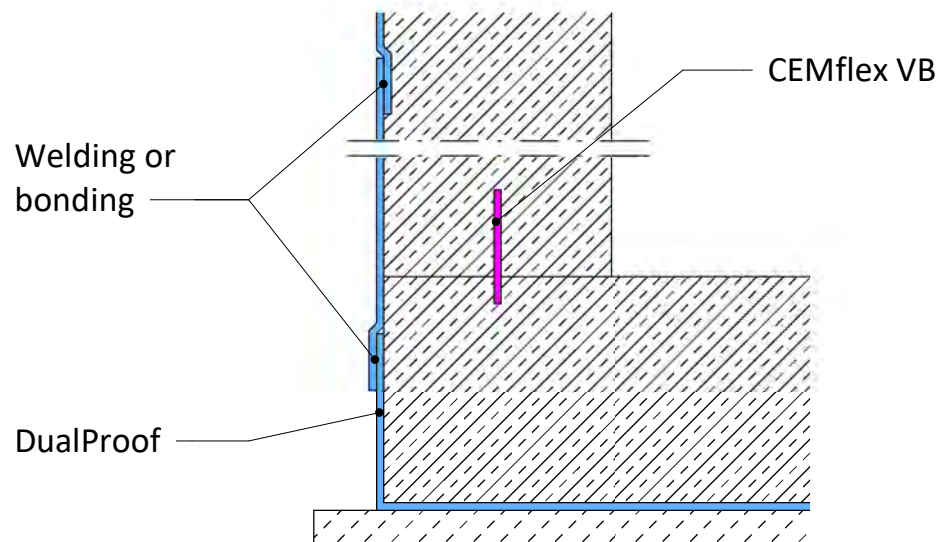
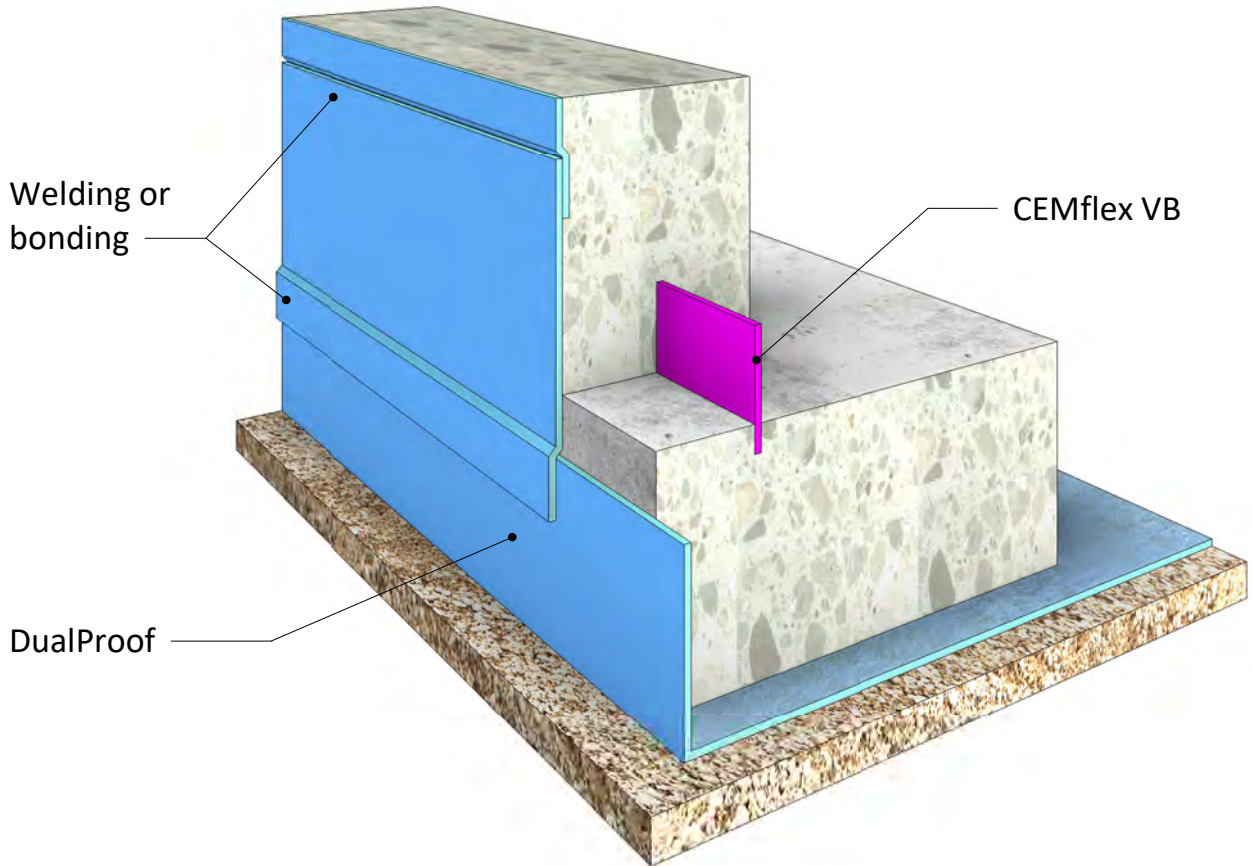

Project:

Title: 2b Floor Slab / wall

Clients:

Date:

Drawing by TE

BPA © 02/2018

2c Floor Slab / wall

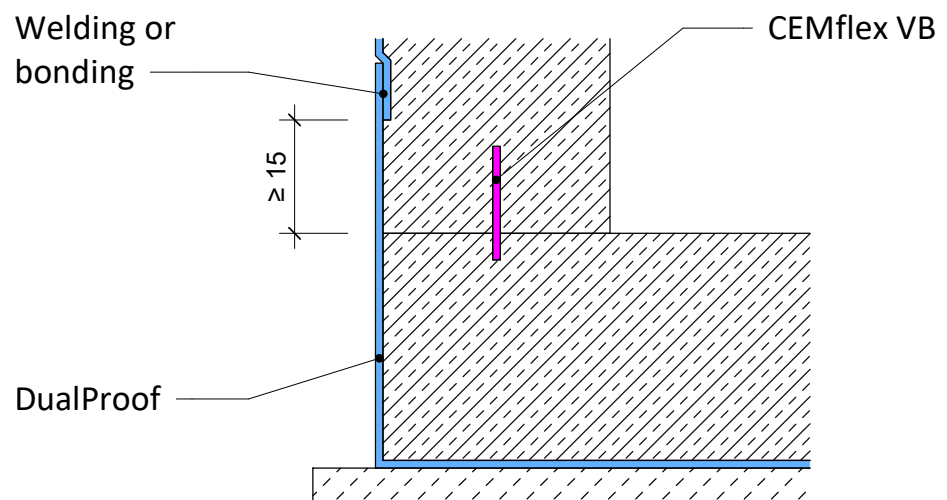
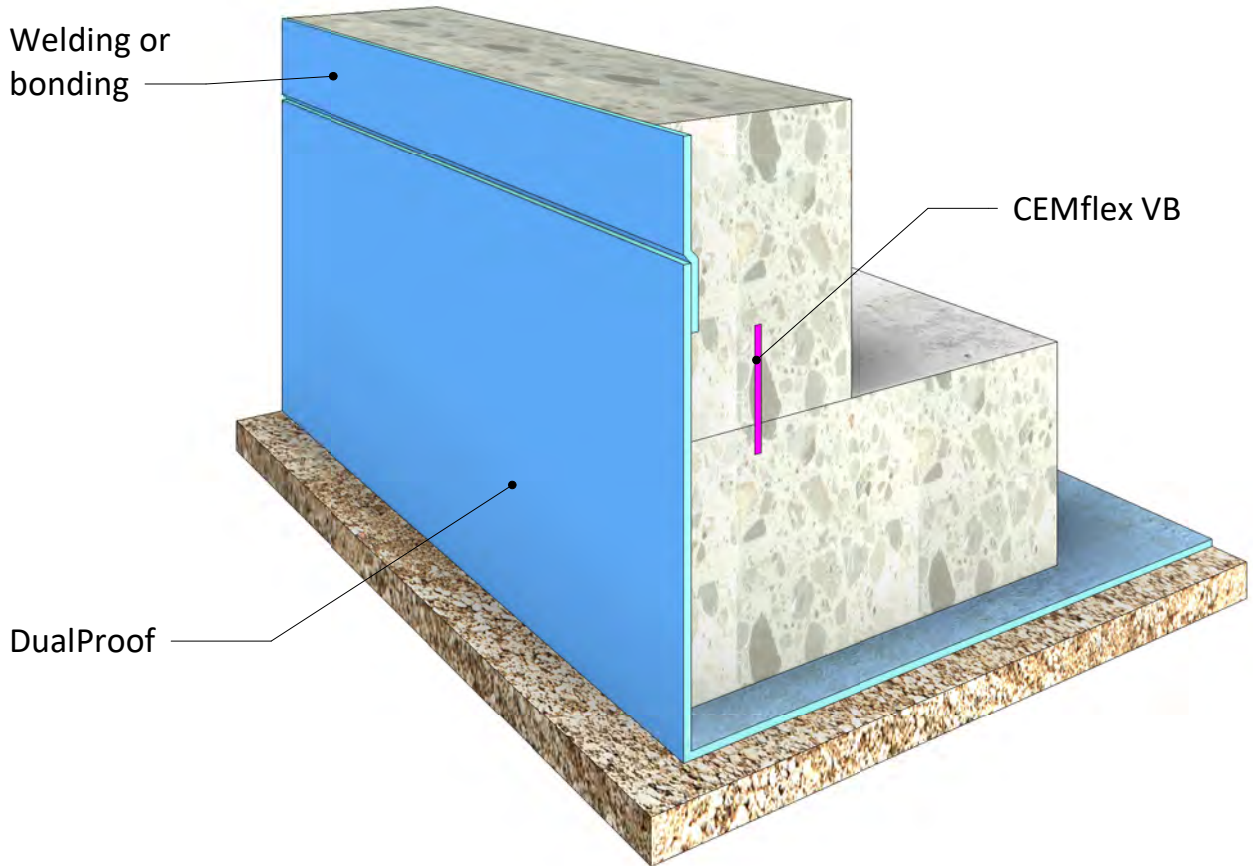

Project:

Title: 2c Floor Slab / wall

Clients:

Date:

Drawing by TE

BPA © 02/2018

3 Expansion Joint

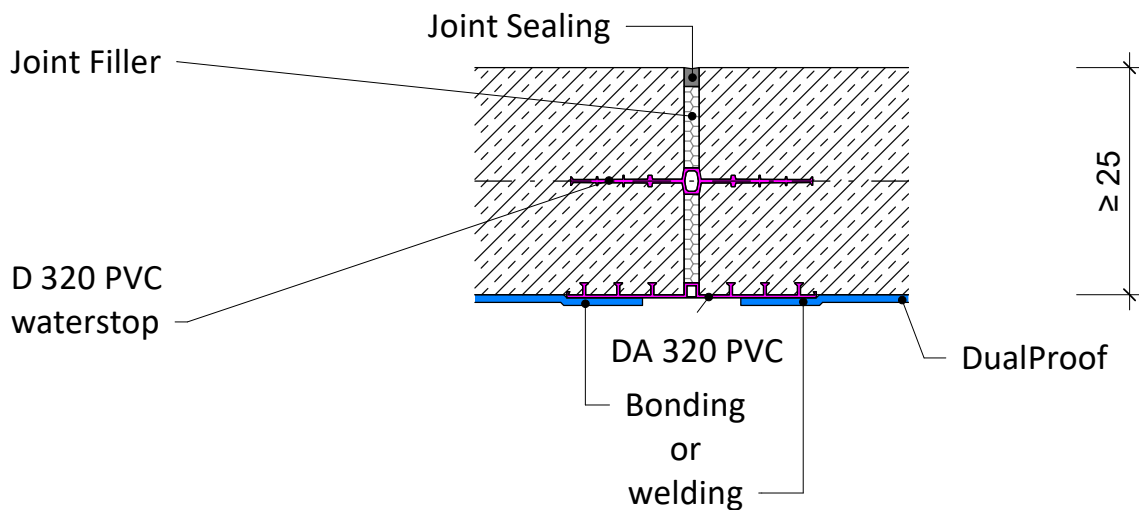
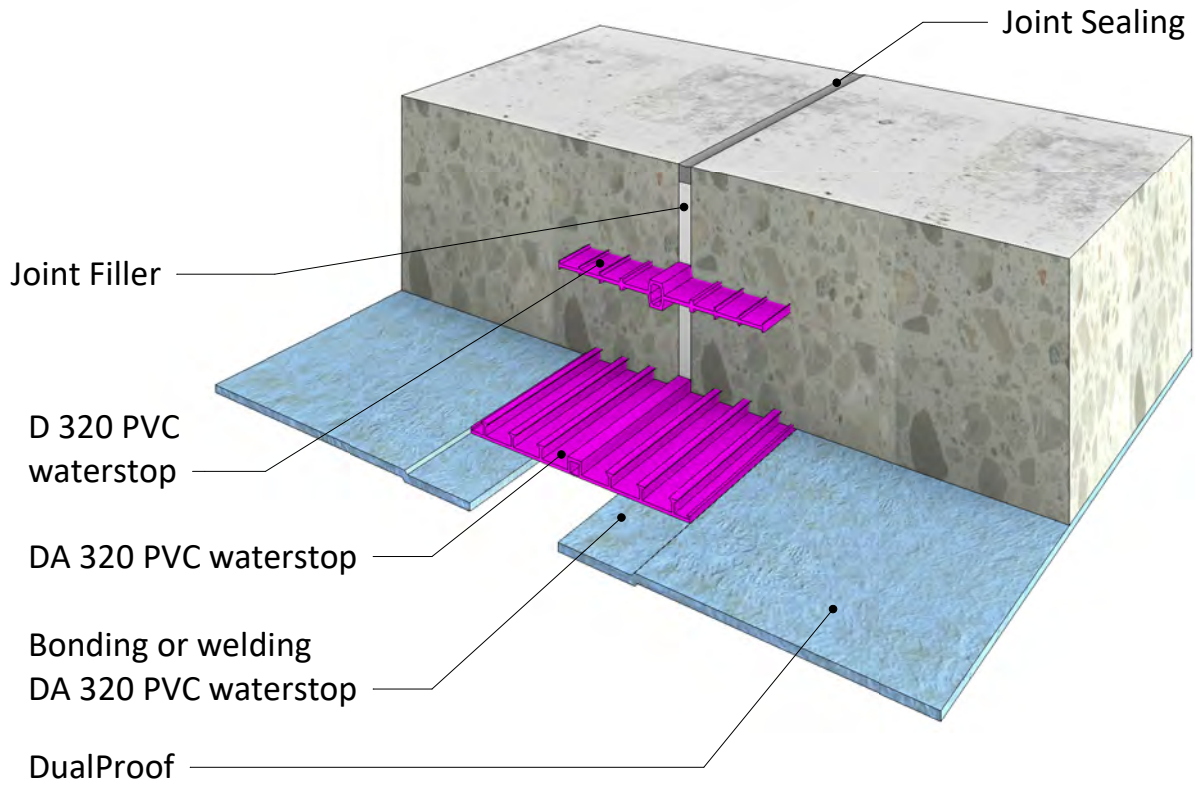

Project:

Title: 3 Expansion Joint

Clients:

Date:

Drawing by TE

BPA © 02/2018

4 Construction Joint horizontal

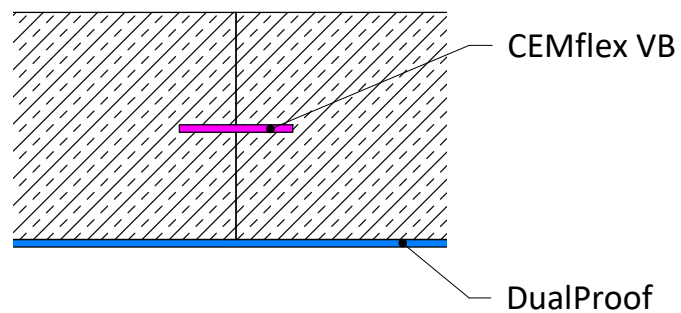
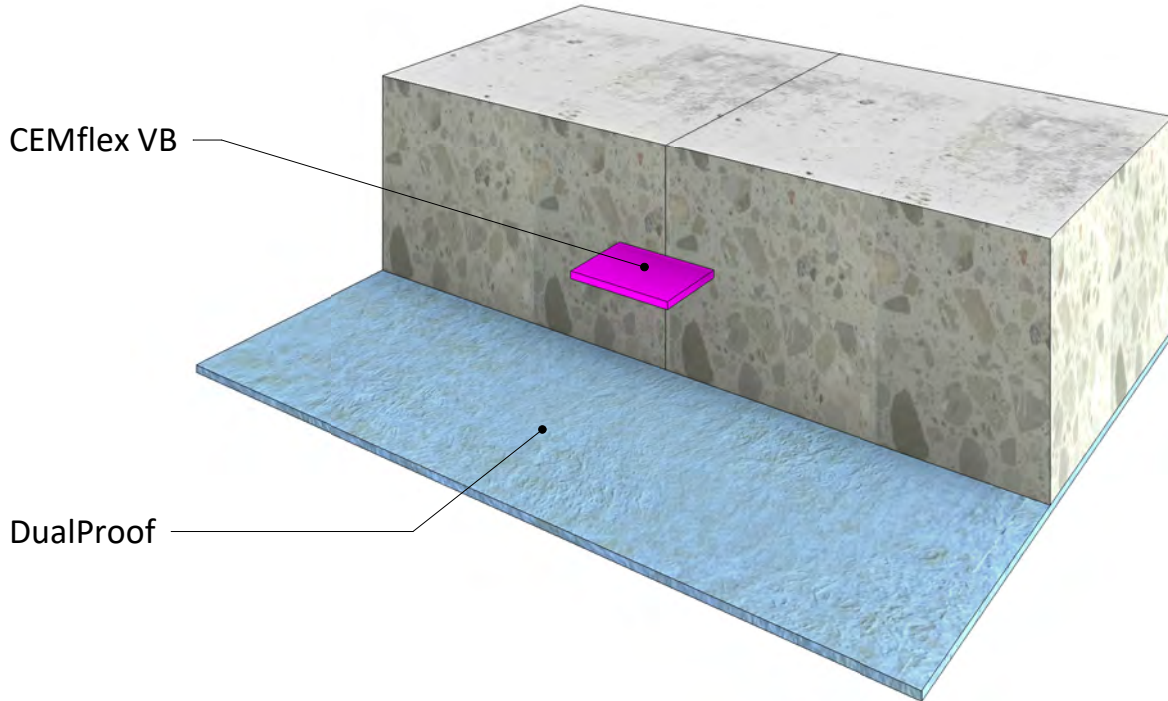

Project:

Title: **4 Construction Joint horizontal**

Clients:

Date:

Drawing by TE

BPA © 02/2018

5a Concrete Pile

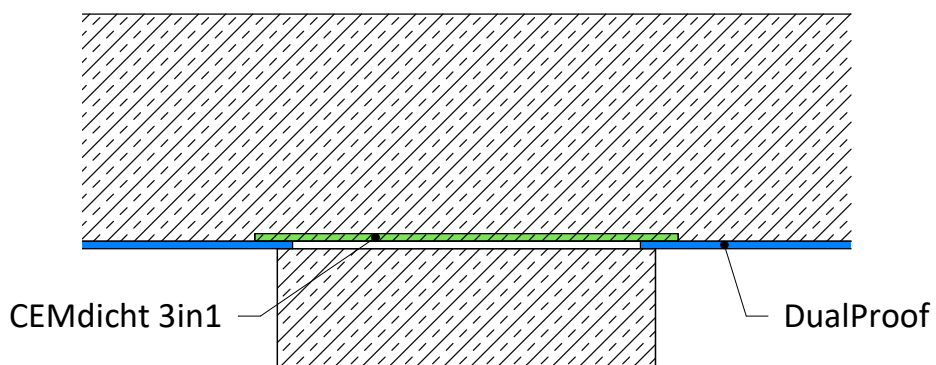
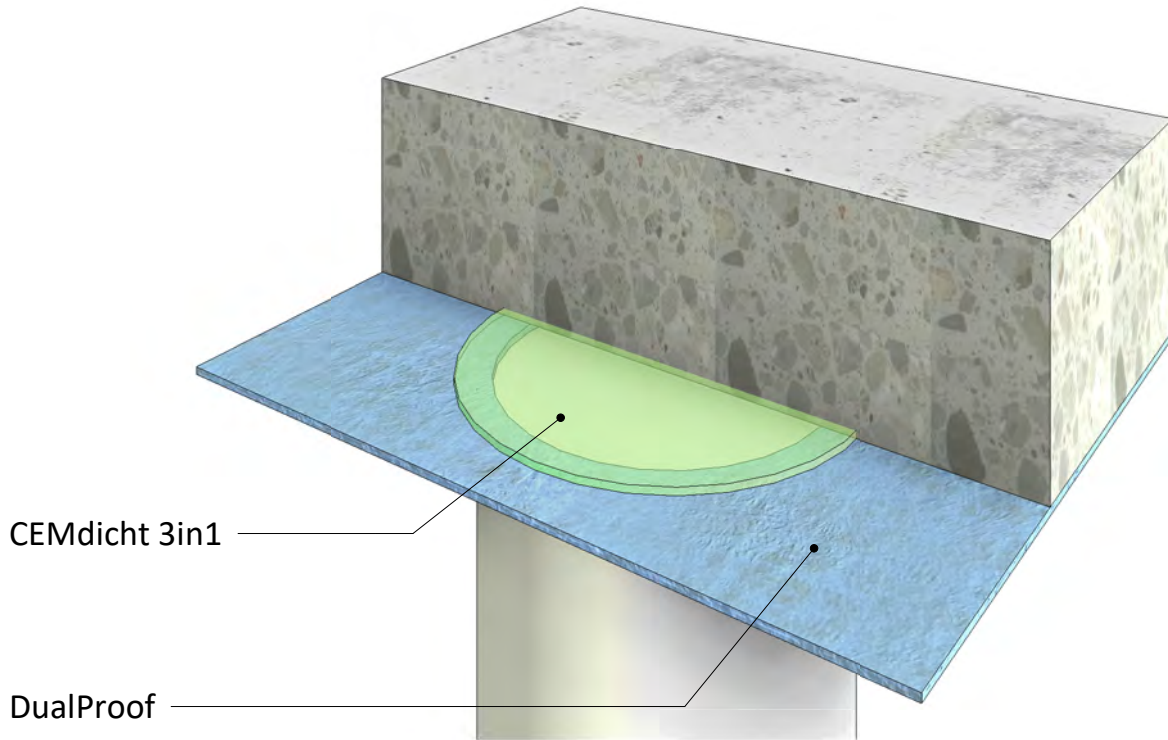

Project:

Title: **5a Concrete Pile**

Clients:

Date:

Drawing by TE

BPA © 02/2018

5b Concrete Pile

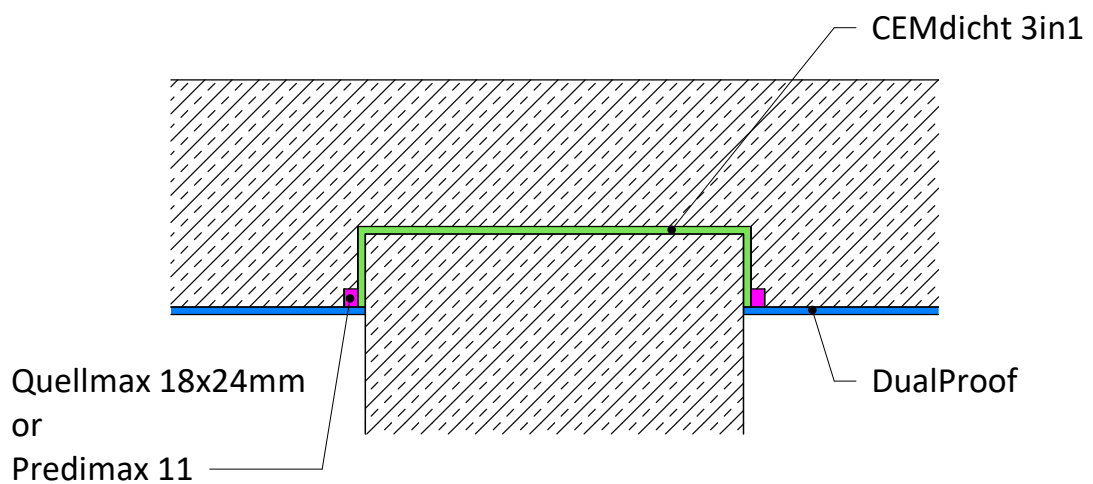
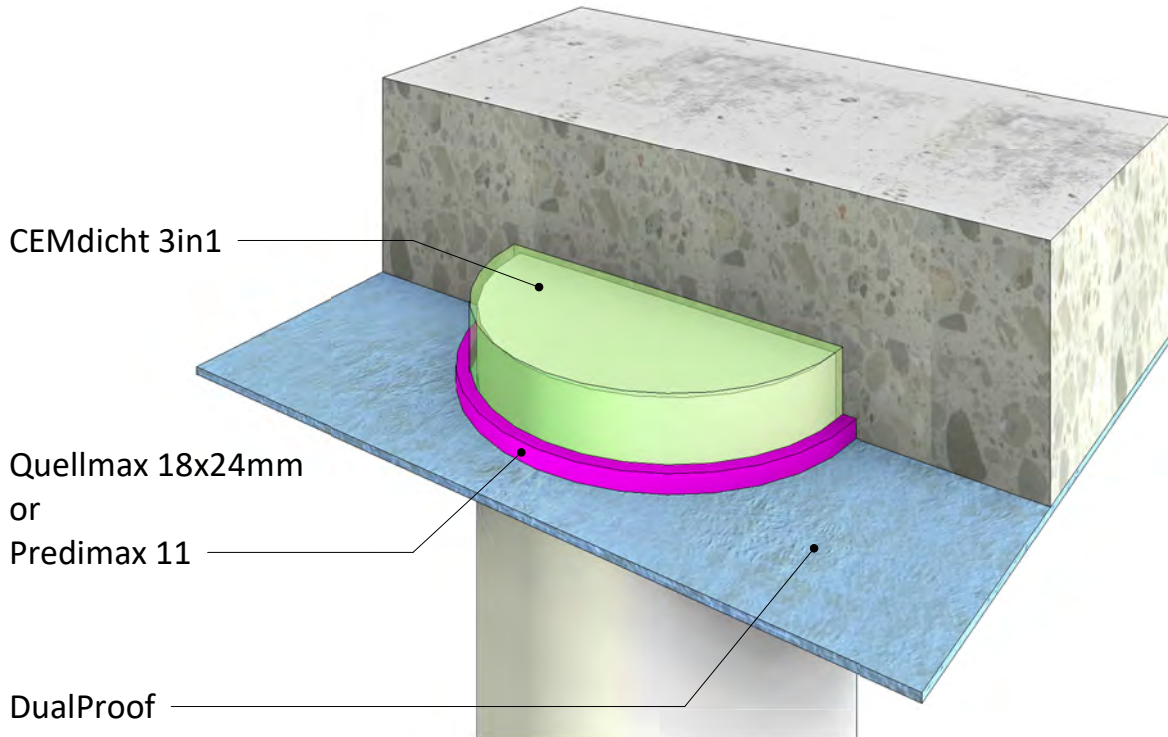

Project:

Title: 5b Concrete Pile

Clients:

Date:

Drawing by TE

BPA © 02/2018

6 Pipe Penetration Floor Slab

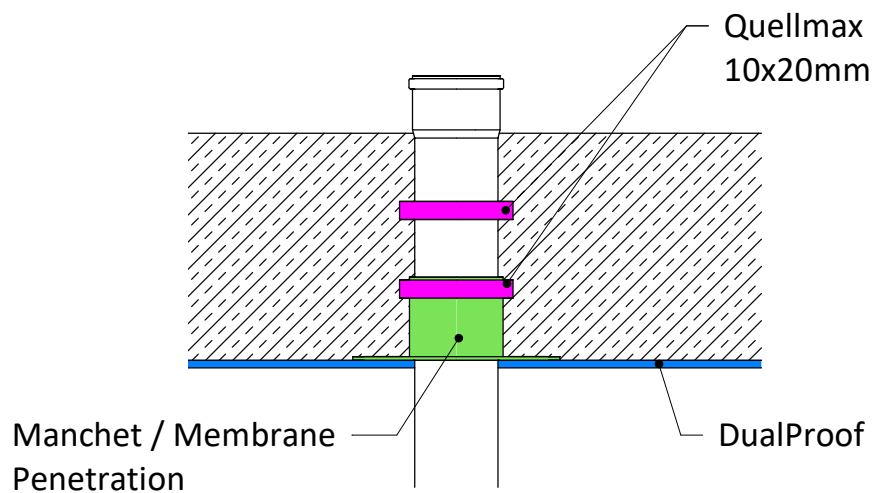
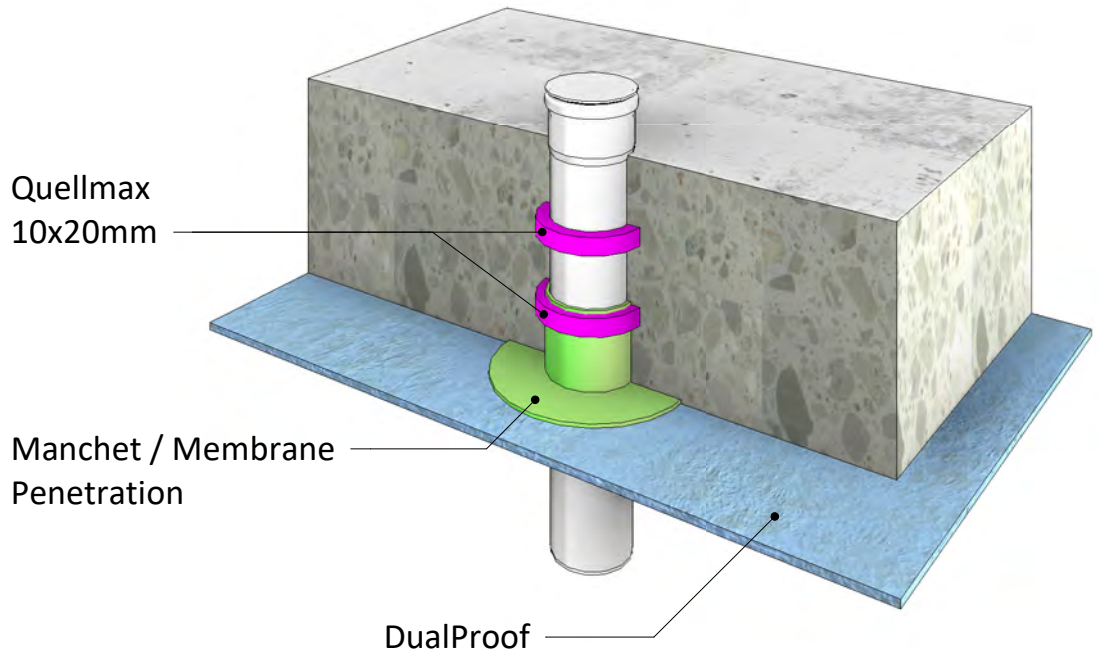

Project:

Title: **6 Pipe Penetration Floor Slab**

Clients:

Date:

Drawing by TE

BPA © 02/2018

7 Steel Pile

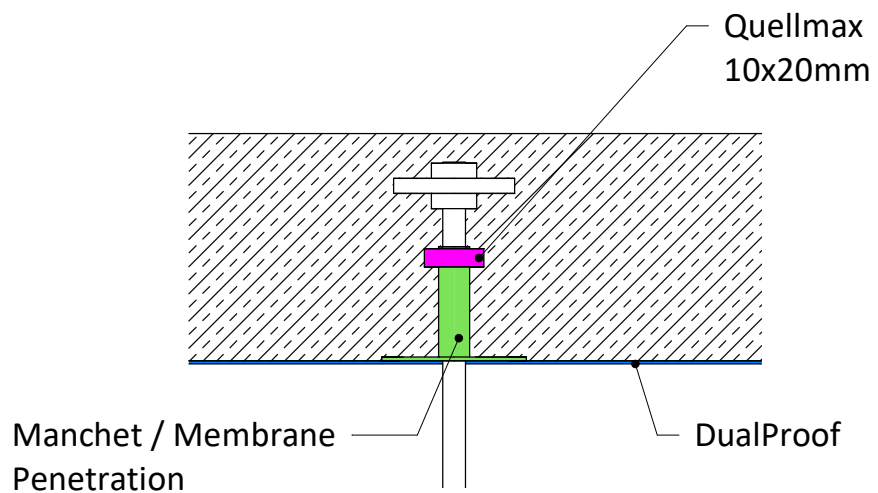
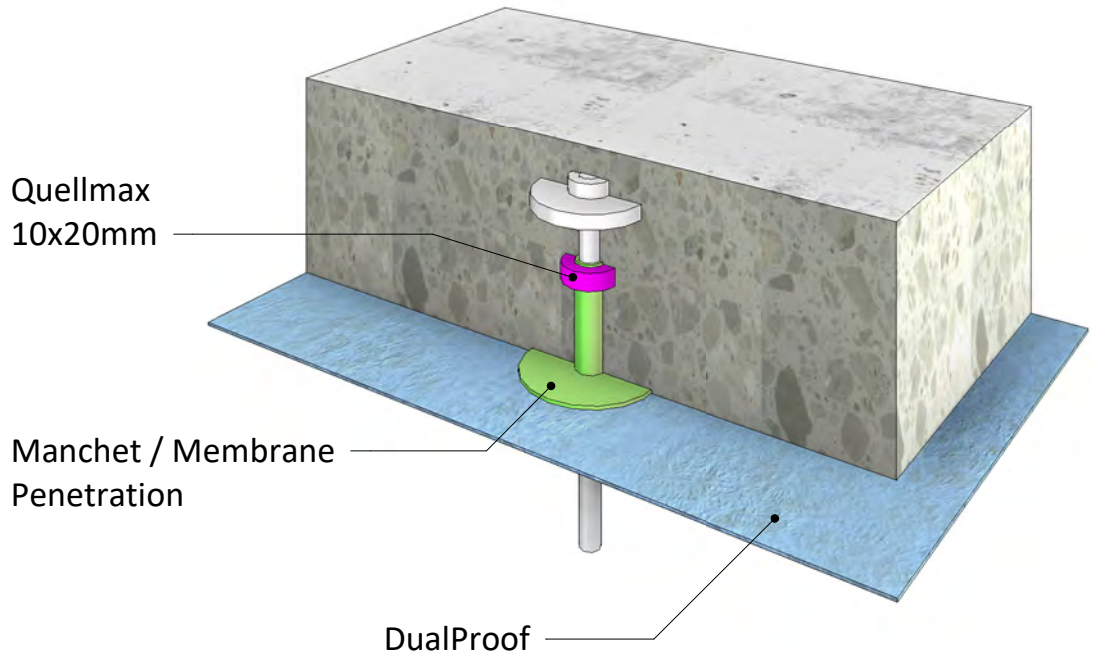

Project:

Title: 7 Steel Pile

Clients:

Date:

Drawing by TE

BPA © 02/2018

8a Blind side Waterproofing Concrete Pile

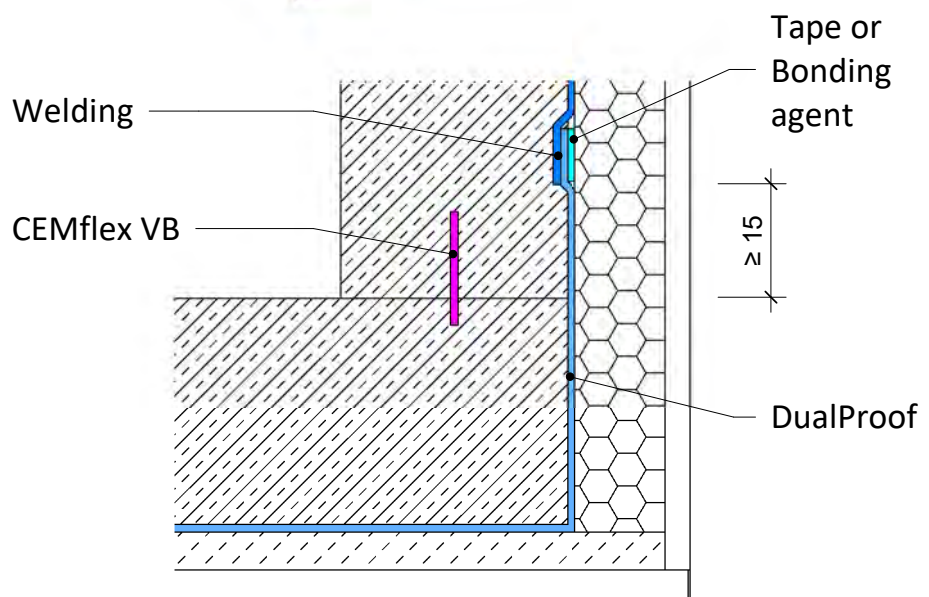
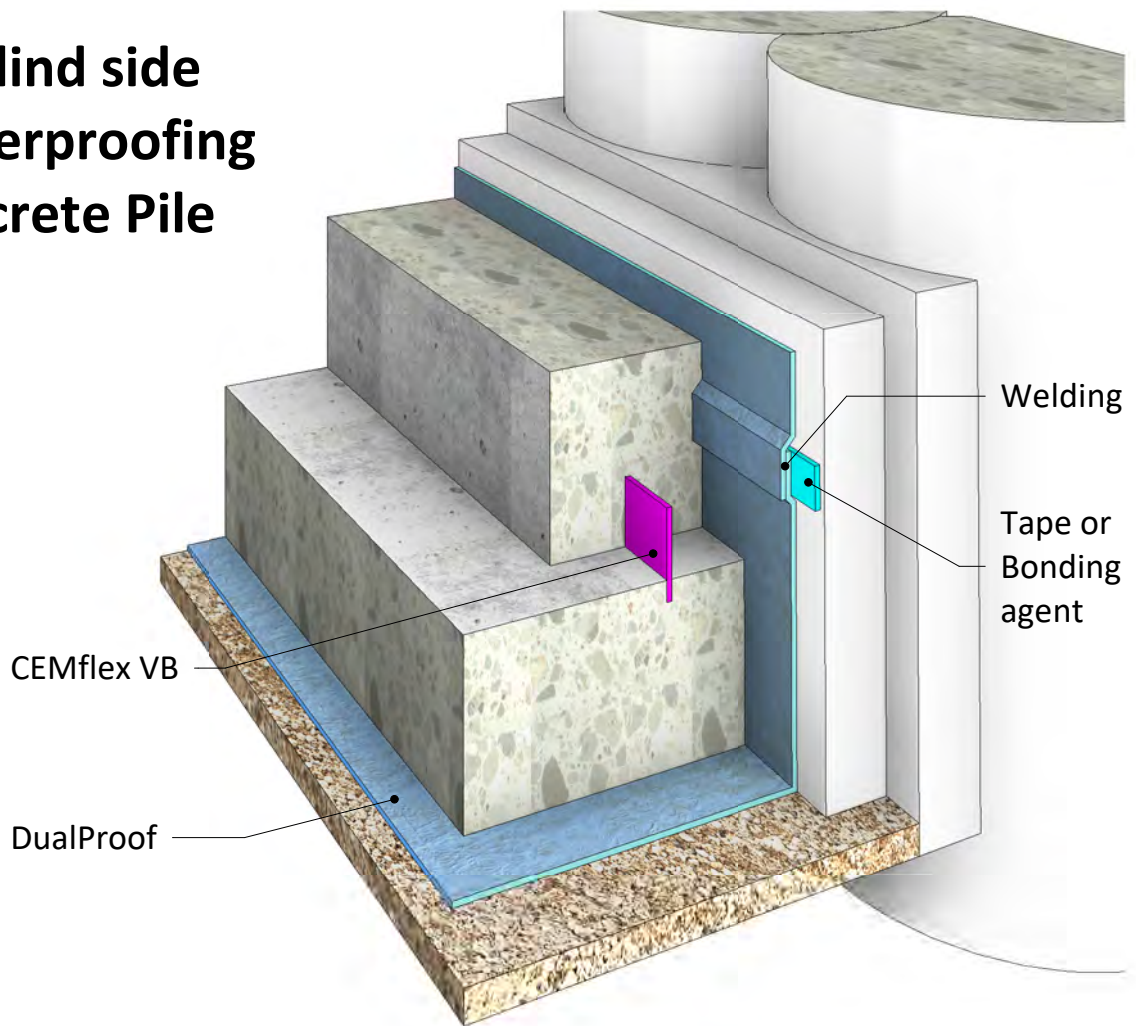

Project:

Title: **8a Blind side Waterproofing Concrete Pile**

Clients:

Date:

Drawing by TE

BPA © 02/2018

8b Blind side Waterproofing Sheet Pile

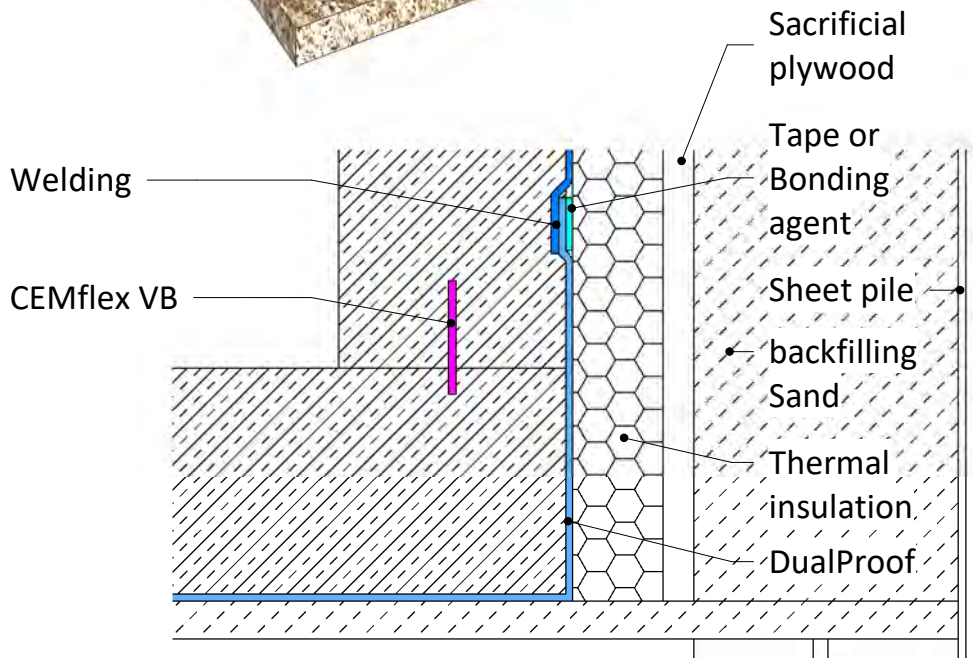
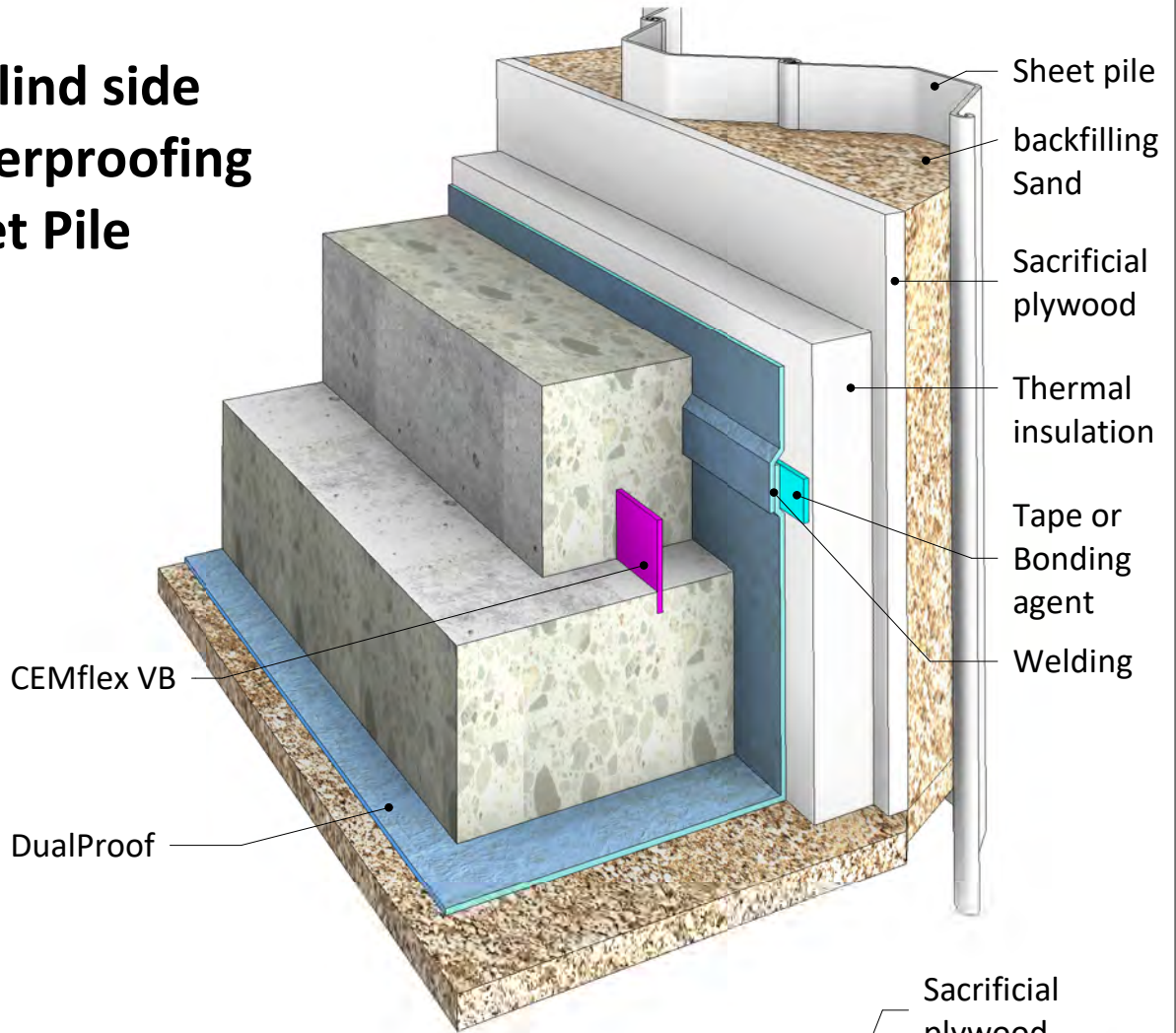

Project:

Title: **8b Blind side Waterproofing Sheet Pile**

Clients:

Date:

Drawing by TE

BPA © 02/2018

www.dichte-bauwerke.de

BPA GmbH
Behringstr. 12
D-71083 Herrenberg-Gültstein
Tel.: +49 (0) 7032 / 89399-0
Fax: +49 (0) 7032 / 89399-29
eMail: bpa@dichte-bauwerke.de
Internet: www.dichte-bauwerke.de