

HD 200 Heavy-Duty Prop

The tool-free assembled prop
for loads up to 200 kN

Product Brochure – Issue 11/2017

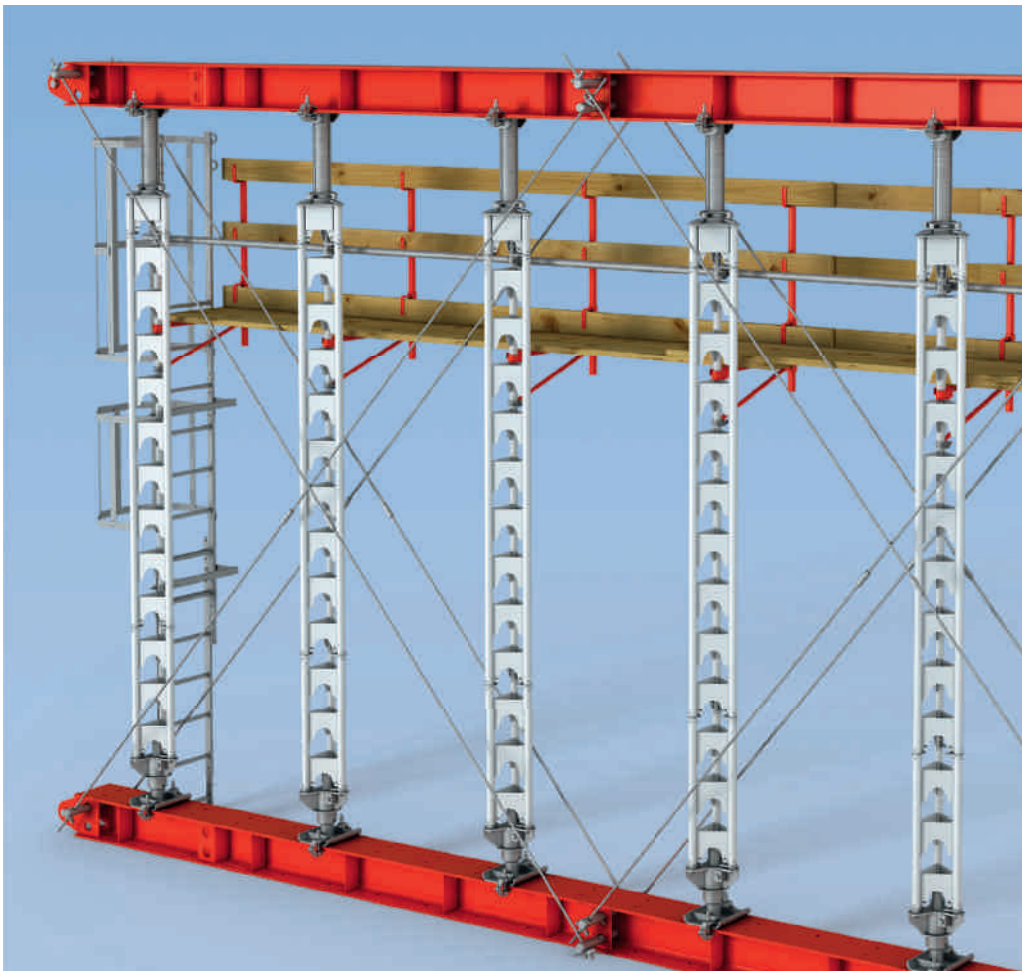

Content

System advantages

- 5 The tool-free assembled prop for loads up to 200 kN
- 6 Uncomplicated, very light and extremely practical
- 7 Can be extended to form main beam areas

System overview

- 8 Design details
- 10 Site-compliant accessories developed for easy use

Issue 11/2017

Publisher

PERI GmbH
Formwork Scaffolding Engineering
Rudolf-Diesel-Strasse 19
89264 Weissenhorn
Germany
Phone +49 (0)7309.950-0
Fax +49 (0)7309.951-0
info@peri.de
www.peri.de

	Project examples
12	HD 200 Heavy-Duty Prop in use

	Components
14	Components

Important information

All current safety regulations and guidelines applicable in those countries where our products are used must be observed.

The images shown in this brochure feature construction sites in progress. For this reason, safety and anchor details in particular cannot always be considered as conclusive or final. These are subject to the risk assessment carried out by the contractor.

In addition, computer graphics are used which are to be understood as system representations. For ensuring a better understanding, these and the detailed illustrations shown have been partially

reduced to show certain aspects. The safety installations which have possibly not been shown in these detailed descriptions must nevertheless still be available. The systems or items shown might not be available in every country.

Safety instructions and load specifications are to be strictly observed at all times. Separate structural calculations are required for any deviations from the standard design data.

The information contained herein is subject to technical changes in the interests of progress. Errors and typographical mistakes reserved.



HD 200 Heavy-Duty Prop

The tool-free assembled prop for loads up to 200 kN

PERI HD 200 is the solution for higher loads. Individual HD 200 props can carry up to 200 kN; furthermore, the system can be used as a main beam area.

In particular, the low weight and easy handling of the HD 200 guarantees fast assembly. The props have a maximum assembly height of 12.20 m and are extremely versatile; in addition, they can be connected together to form main beam areas.

- For loads up to 200 kN.
 - Assembly in 30 cm increments up to 12.20 m total height (without intermediate supports).
 - 3 aluminium prop sections (30 cm | 90 cm | 270 cm) and 2 steel sections (90 cm | 210 cm).
 - Head Spindle with Head Plate that can be tilted up to 3°.
 - Lowering Device with 10 cm lowering range for easy lowering under full load.
- Shoring prop consisting of coupled aluminium sections for medium-heavy shoring (steel sections for higher loads and larger support heights); can also be used as main beam area.

Fast assembly requiring no tools

through integrated chord couplings for connecting the individual sections

Assembly by hand

with lightweight individual components – the largest aluminium section weighs less than 30 kg

Controlled lowering

up to 10 cm with the lowering device

Can also be used as a main beam area

by connecting the props by means of main beams; diagonal bracing with system components without requiring any welding



Uncomplicated, very light and extremely practical

The HD 200 is comprised of prop sections and can be assembled in 4 different lengths. Thanks to the chord couplings on the individual sections, assembly can be carried out without tools. This connection is permanently attached on each section.

One key objective during the development of the HD 200 was that the system components could be moved by hand. Therefore, aluminium sections are mainly used throughout. The largest aluminium individual section weighs less than 30 kg. As a result, the HD 200 is considerably lighter than conventional heavy-duty props.

Cross-sections of HD 200 individual sections. Any scaffold tube bracing required can be connected to the $\varnothing 48.3$ mm diameter chord section.

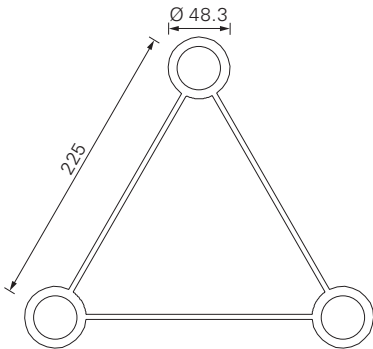

Two individual steel sections expand the range of applications; they are used for higher loads and achieve longer prop heights.

The lowering device allows controlled lowering of loads of up to 20 t – a simple procedure using a cordless screwdriver (no impact function).

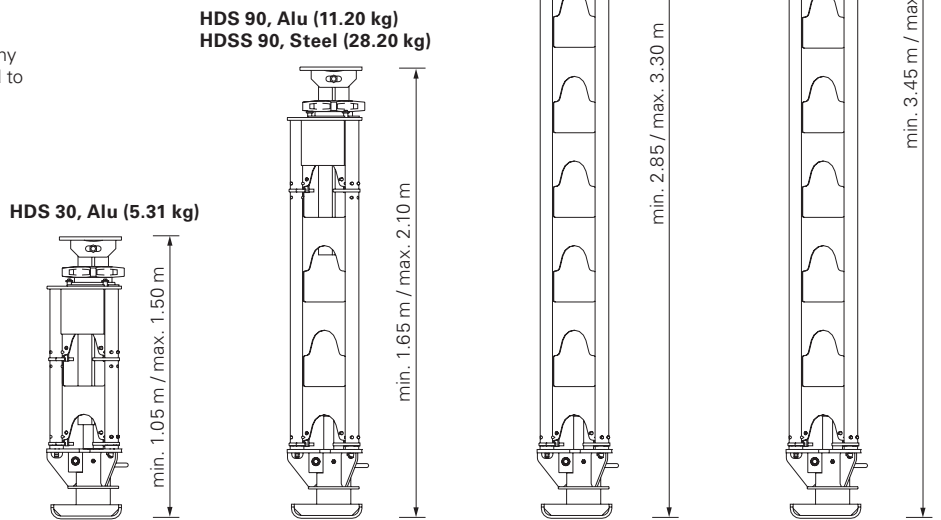

The lowering device with a lowering range of 10 cm for easy striking under full load swivelling 3° to all sides.



The HD prop elements are simply placed on top of each other by hand ...



... and quickly connected by turning the chord couplings.

Can be extended to form main beam areas

Using HDT System Main Beams as top and base beams, HD 200 individual props are coupled together to form longer supporting structures.

This main beam area provides a very cost-effective solution in particular for bridge constructions. Tie Rods DW 15 are used for bracing the main beam frames whilst scaffold tubes $\varnothing 48$ and couplers form the diagonal bracing.

With this portal-like shoring construction comprised of standard components taken from the HD 200 heavy-duty system, traffic could flow freely during the construction period. In the heavily loaded middle section of the props, steel segments (easily identifiable through the red colour) ensure the safe transfer of loads.

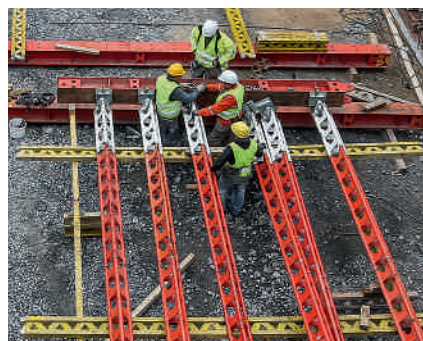

The main beam area is normally assembled horizontally – complete with diagonal bracing, working platform and access ladder.



HD 200 as main beam section for the building of a road crossing using a steel composite construction method.

Design details

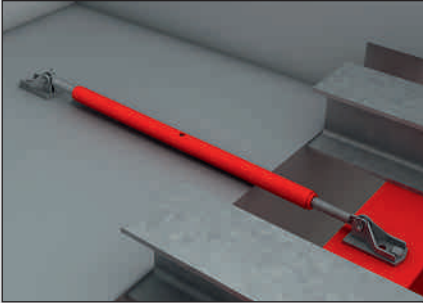

Connecting Plate and Cross-Connector allow Kickers and Push-Pull Props to be fixed. This arrangement is used to carry horizontal forces and align primary beams.

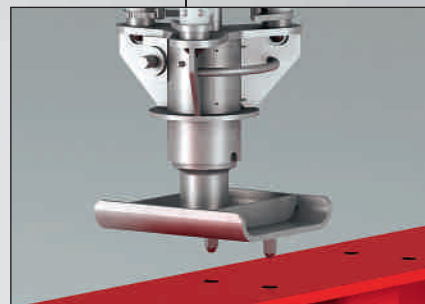
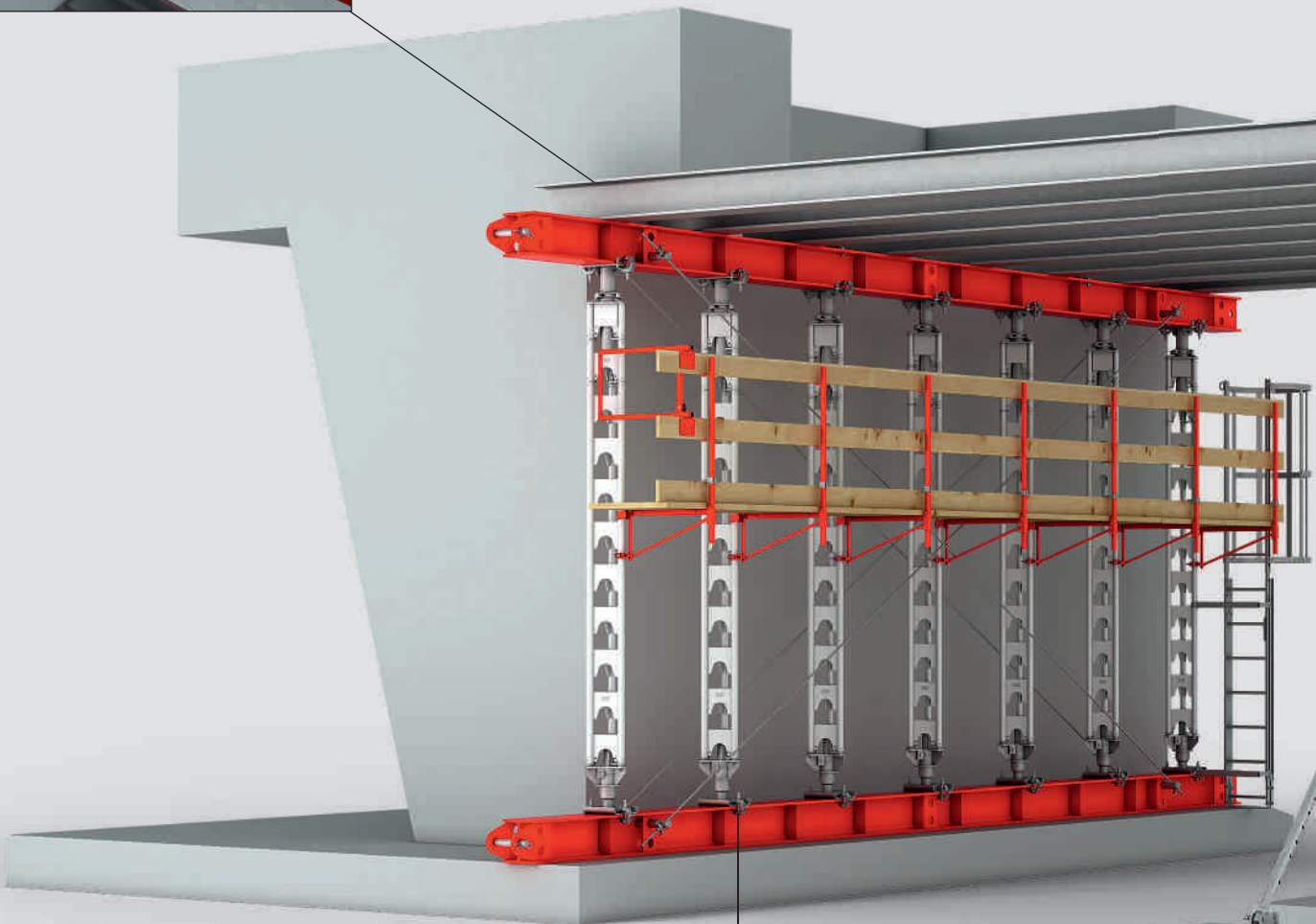

Centring Bolt HD M12
For accurate positioning of the Lowering Device HDA or Head Spindle HDK 45 on the Main Beam HDT.

Double Anchor Tie Yoke HDD and Wing Nut

For transferring the horizontal loads, diagonal bracing is used on both sides of the main beam area:

The Double Anchor Tie Yoke is inserted into the main beam, Tie Rods DW 15 are positioned diagonally. Subsequently, the DW 15 is uniformly tensioned by means of a Cam Nut or Wing Nut.

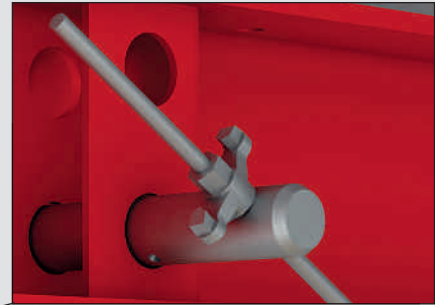

Brace Connector HDR

For connecting Push-Pull Props to HDS Prop Sections.

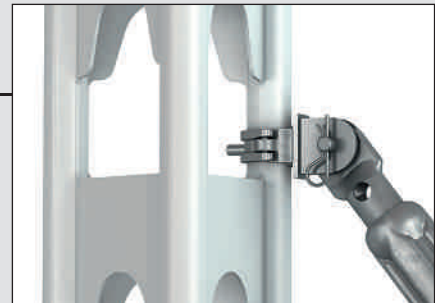

Main Beam Clamp HD, 40 mm

Used to help erect the prop sections, and for connecting primary and secondary beams (also independent of hole grid).

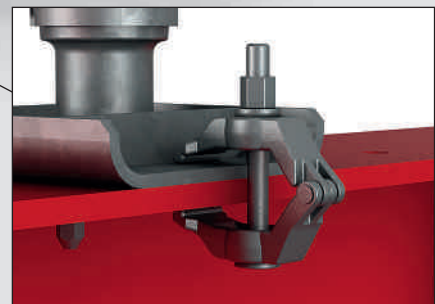

Site-compliant accessories developed for easy use

PERI places great importance on the site benefits in terms of utilisation and accessories, and hence the cost-effectiveness of the construction. The HD 200 also has an extensive range of accessories.

Main Beam HDT

The beam comes in different lengths and has coupling connections, end-to-end perforations for centring the props, and holes for diagonal bracing with pre-stressed steel.

Trolley HD

The trolley is used for removing the longitudinal beams under the concreted member. It can move loads of up to 2,500 kg.

Scaffold Bracket 75 HD

The use of scaffold brackets provides safe working conditions on the shoring.

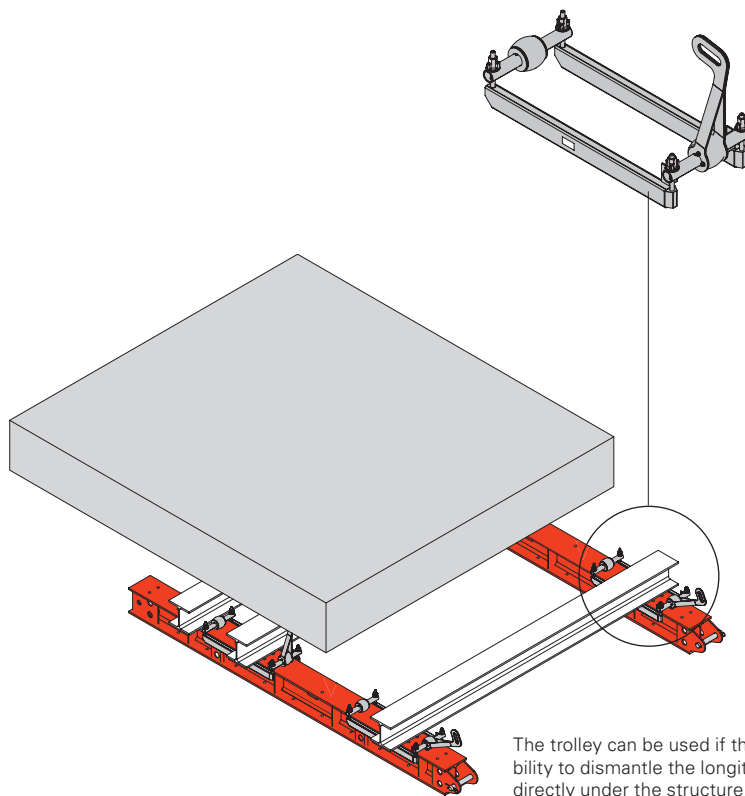

The trolley can be used if there is no possibility to dismantle the longitudinal beam directly under the structure.



Ladders with safety cages, which are attached to the prop chords, guarantee safe access.



Diagonal bracing mounted on both sides of the main beam area stabilizes the unit and transfers the horizontal loads.

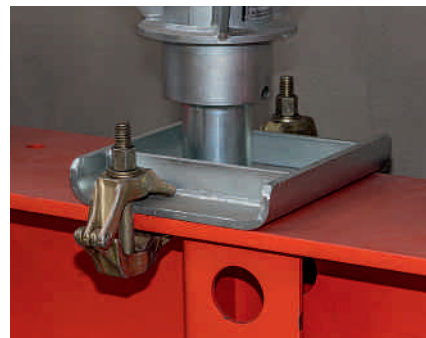

Main beam clamps can be used to fasten pre-assembled HD Props to the base and head beam.



The Wing Nut Spanner HD is used to release the Compression Brace Spindle HD, Head Spindle HDK 45 or spindles fitted with the Adjusting Nut TR 110.

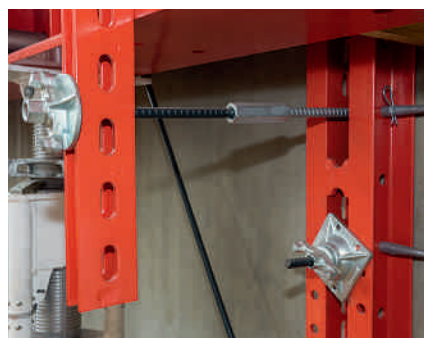

Horizontal loads at right-angles to the level of the main beam frame are transferred directly from the Main Beam HDT into existing structures e.g. abutment.



With the Scaffold Bracket, a 75 cm wide working platform can be realised.

HD 200 Heavy-Duty Prop in use



HD 200 Heavy-Duty Props as a space-saving solution: 8 m high props transfer the loads from a working and safety scaffold in a confined area.



A lightweight but load-bearing solution: Below the shear walls, HD 200 Heavy-Duty Props transfer linear loads of up to 400 kN/m into the bottom plate.



Transferring high loads with low space requirements – making full use of the advantages of the HD 200 Heavy-Duty Prop for the construction of a power plant.



HD 200 Props as bracing: The heavy-duty props offset the horizontal loads generated from the concrete pressure; this avoids costly and time-consuming anchor solutions.



HD 200 Heavy-Duty Props as a full-surface shoring structure. The HD 200 sections were joined together, also at great heights, in order to safely transfer the loads of the 3.20 m thick reinforced concrete slab for the generator.



The moveable longitudinal truss – taken from the HD 200 heavy-duty system – for this tunnel was designed as a portal. This allowed a continuous flow of site traffic at all times.

For the construction of this bridge, HD 200 main beam areas were used directly to support the precast girders of the superstructure.



For this underground structure, HD 200 individual props reliably carry the high loads resulting from the subsequent construction work.



HD 200 Heavy-Duty Prop



Item no.	Weight kg		L	X
022006	5.090	Prop Sections HDS / HDSS		
		Prop Section HDS 30 Alu	340	300
022005	11.200	Prop Section HDS 90 Alu	940	900
022004	29.600	Prop Section HDS 270 Alu	2740	2700
111276	28.200	Prop Section HDSS 90 Steel	940	900
103993	63.500	Prop Section HDSS 210 Steel	2140	2100

Prop sections made of aluminium or steel. With chord couplings for connecting to other sections.

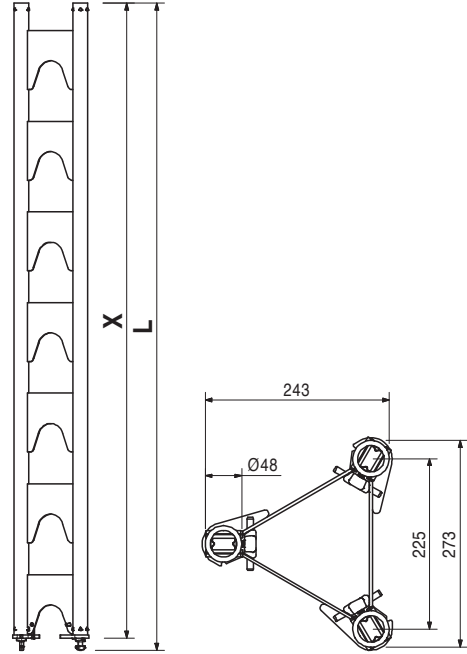
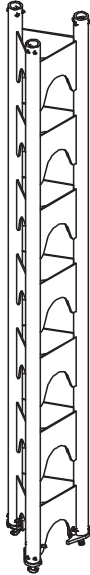

022020	3.310	Coupling Section HD 30		
--------	-------	-------------------------------	--	--

With connection possibility of chord couplings on both sides e.g. when using HD 200 segments with Head Spindle HDK at both ends.

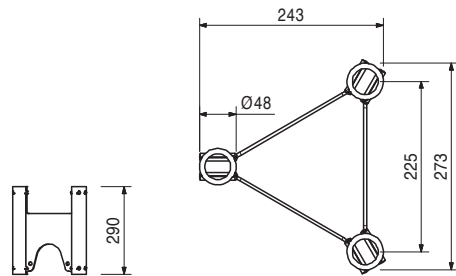

HD 200 Heavy-Duty Prop



Item no.	Weight kg
022003	32.100

Lowering Device HDA

For easy release of higher loads with the HD 200. Lowering range max. 10 cm. Tiltable on all sides up to 3°.

Note

Follow Instructions for Assembly and Use!

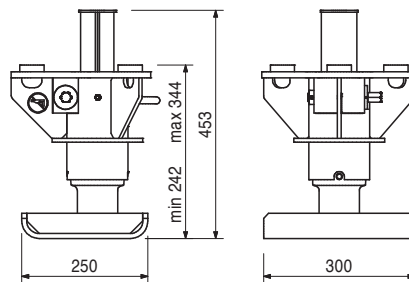
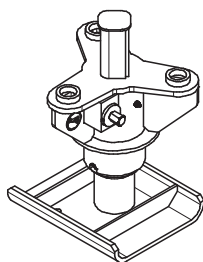

Accessories

022018	0.002
--------	-------

Shear Pin HDA

022018	0.002
--------	-------

Shear Pin HDA

For mounting in the Lowering Device HDA.

022007	24.600
--------	--------

Head Spindle HDK 45

Head spindle for Heavy-Duty Prop HD 200. With integrated chord couplings for connecting the chord tubes. Can be tilted up to 3° along one axis.

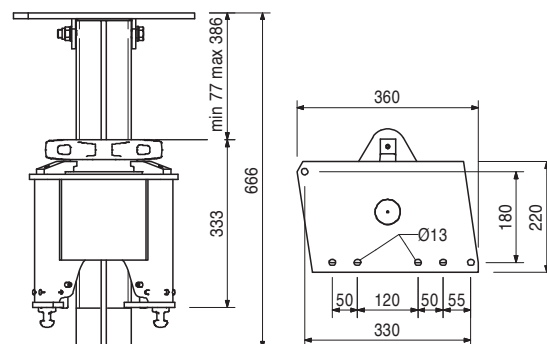
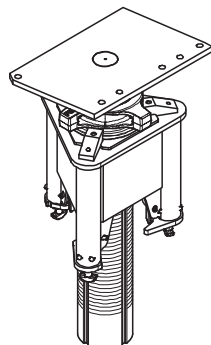

Accessories

022027	3.600
--------	-------

Wing Nut Spanner HD

022027	3.600
--------	-------

Wing Nut Spanner HD

For easy release of the Head Spindle HDK 45, the Head Spindle TR 110-80/55 and the MULTIPROP Slab Prop.

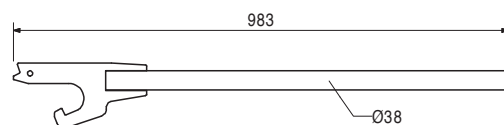
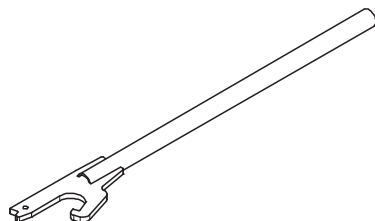

HD 200 Heavy-Duty Prop



Item no.	Weight kg
022013	0.137

Centring Bolt HD M12, galv.
For the HD 200 System.

Complete with
1 pc. 710330 Nut ISO 4032 M12-8, galv.

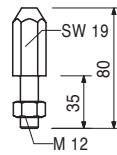

022019	18.500
--------	--------

Base Adapter HD
For using HD 200 Prop Sections directly on Main Beams HDT when lowering function is not required e. g. travelling truss of tunnel carriage.

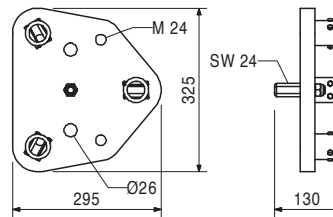
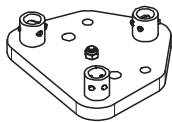

131723	1.440
--------	-------

Brace Connector HDR-2
For connecting push-pull props and kicker braces to components Ø 48 mm.

Complete with
1 pc. 027170 Pin Ø 16 x 42, galv.
1 pc. 018060 Cotter Pin 4/1, galv.

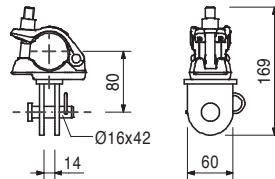
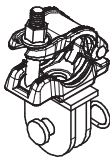

022016	1.290
--------	-------

Brace Connector HDR
For connecting push-pull props and kicker braces to components Ø 48 mm.

Complete with
1 pc. 027170 Pin Ø 16 x 42, galv.
1 pc. 018060 Cotter Pin 4/1, galv.

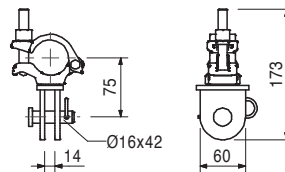
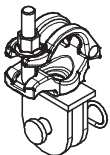

028080	2.970
--------	-------

Connector Kicker/ Push-Pull Prop, galv.
For connecting push-pull props and kicker braces to Main Beam HDT.

Complete with
1 pc. 018060 Cotter Pin 4/1, galv.
1 pc. 027170 Pin Ø 16 x 42, galv.

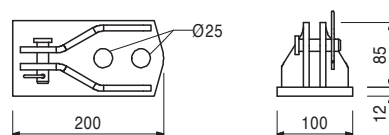
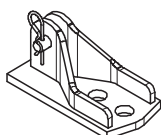

HD 200 Heavy-Duty Prop



Item no.	Weight kg
117343	3.250

Base Plate-2 for RS 210 - 1400, galv.
 For assembly of Push-Pull Props RS 210, 260, 300, 450, 650, 1000 and 1400.

Complete with
 2 pc. 105400 Pin \varnothing 20 x 140, galv.
 2 pc. 018060 Cotter Pin 4/1, galv.

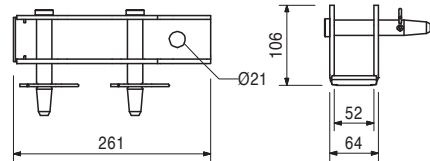
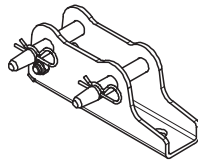

Accessories

124777	0.210
--------	-------

Anchor Bolt PERI 14/20 x 130

124777	0.210
--------	-------

Anchor Bolt PERI 14/20 x 130

For temporary fixation to reinforced concrete structures.

Note

See PERI data sheet!
 Drilling \varnothing 14 mm.

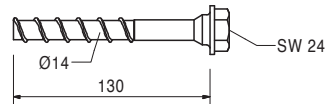
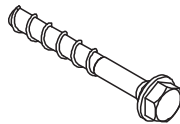

022023	21.800
--------	--------

Compression Brace Spindle HD

For using Prop Sections HDS and HDSS as props (also inclined). Only in connection with Base Plate HD!

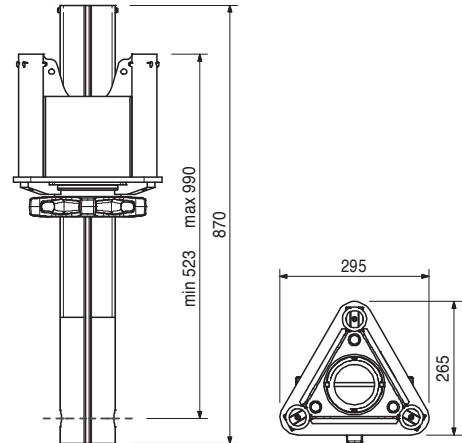
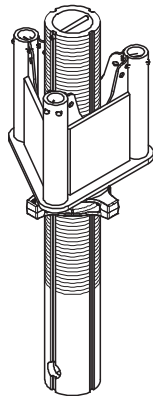

022022	22.000
--------	--------

Compression Head HD

For using Prop Sections HDS and HDSS as props (also inclined).

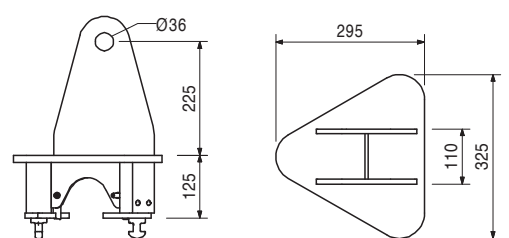
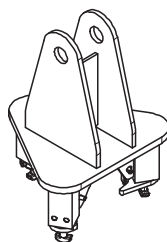

HD 200 Heavy-Duty Prop



Item no.	Weight kg
022024	13.200

Base Plate HD

For using Prop Sections HDS and HDSS as props (also inclined).

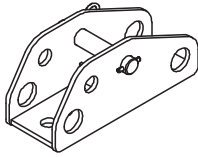

Complete with

1 pc. 722465 Bolt 35 x 160, galv.
1 pc. 710304 Cotter Pin 7, galv.

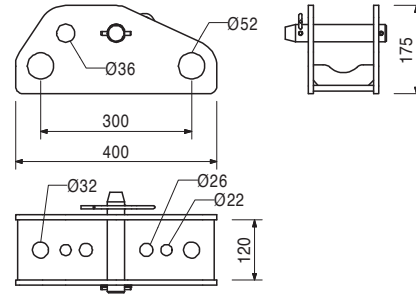

022017	5.190
--------	-------

Scaffold Bracket HD 75

For assembly of working scaffold. With nailing batten.

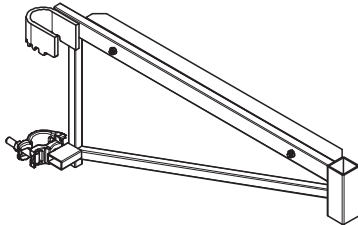

Complete with

1 pc. 116292 Guardrail Post HSGP-2

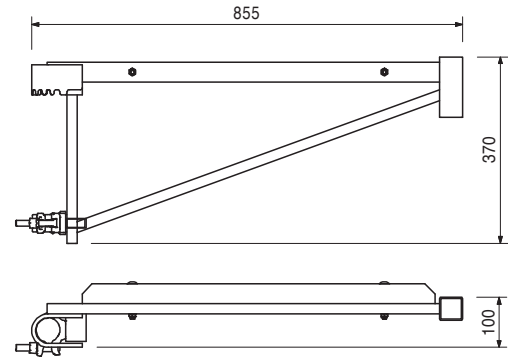

116292	4.720
--------	-------

Accessories

Guardrail Post HSGP-2

116292	4.720
--------	-------

Guardrail Post HSGP-2

As guardrail for different systems.

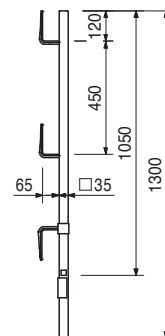

HD 200 Heavy-Duty Prop

Item no.	Weight kg
022008	1130.000

Main Beam HDT 880

System steel girder for use with HD 200 Main Beam areas and special constructions. Profile HEB 300.

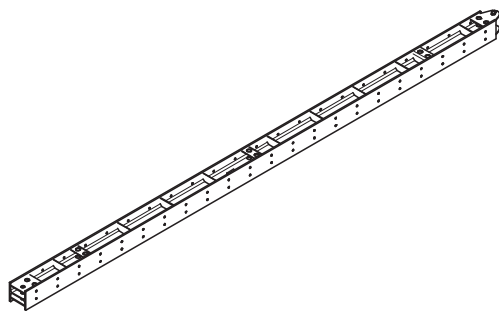

Complete with

- 1 pc. 105435 Bolt Ø 50 x 330
- 1 pc. 722457 Dowel Pin Ø 10 x 70, galv.
- 1 pc. 710618 Cotter Pin 8, galv.

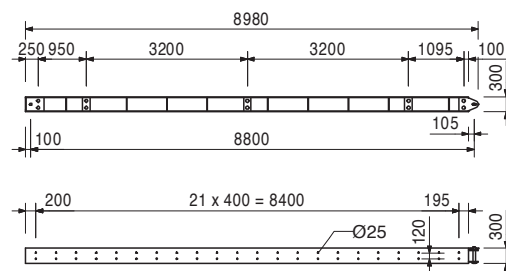

022009	582.000
--------	---------

Main Beam HDT 440

System steel girder for use with HD 200 Main Beam areas and special constructions. Profile HEB 300.

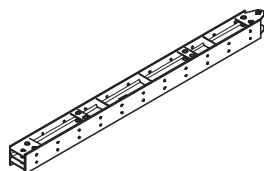

Complete with

- 1 pc. 105435 Bolt Ø 50 x 330
- 1 pc. 722457 Dowel Pin Ø 10 x 70, galv.
- 1 pc. 710618 Cotter Pin 8, galv.

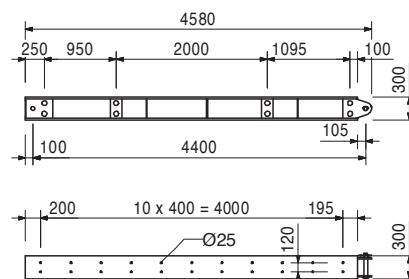

022010	379.000
--------	---------

Main Beam HDT 280

System steel girder for use with HD 200 Main Beam areas and special constructions. Profile HEB 300.

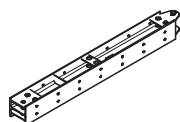

Complete with

- 1 pc. 105435 Bolt Ø 50 x 330
- 1 pc. 722457 Dowel Pin Ø 10 x 70, galv.
- 1 pc. 710618 Cotter Pin 8, galv.

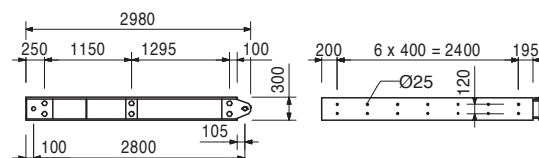

022025	1.970
--------	-------

Centering Bar 40 x 20 x 400

For centering crossbeams on the Main Beam HDT.

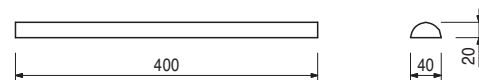
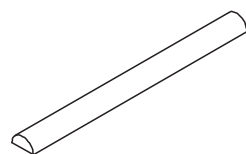

HD 200 Heavy-Duty Prop



Item no.	Weight kg
022011	13.200

Double Anchor Tie Yoke HDD
For anchoring with Tie Rod DW 15 and DW 20.

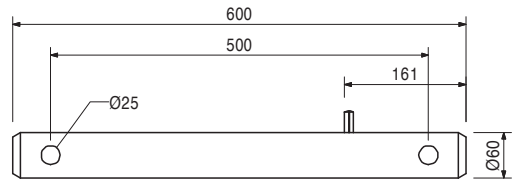
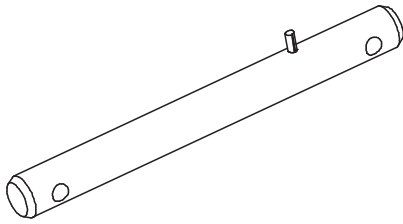

022021	31.900
--------	--------

Trolley HD
For moving longitudinal girders on the Main Beam HDT.

Technical Data
Permissible load-bearing capacity 2.5 t.

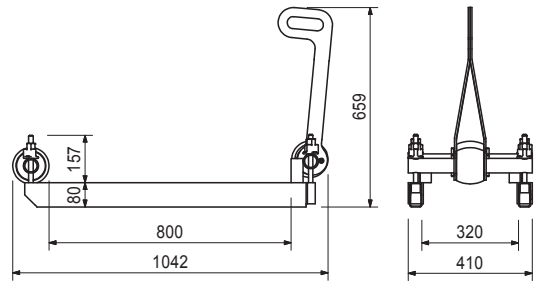
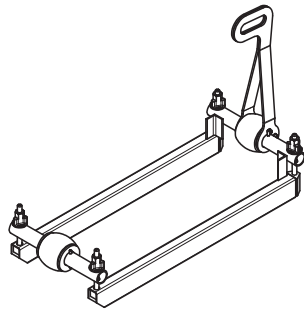

106183	2.200
--------	-------

Main Beam Clamp HD 70 mm, galv.
For connecting crossed girders.

Note
Take official Approval into consideration!
2 for each Head Spindle.

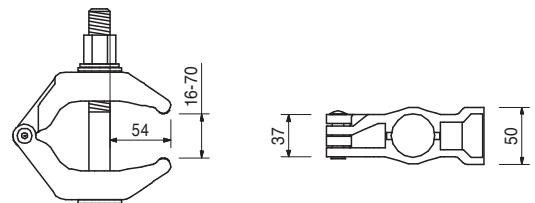
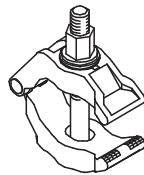

022026	1.780
--------	-------

Steel Beam Clamp IPB 300 - 1000
For providing protection against tipping.

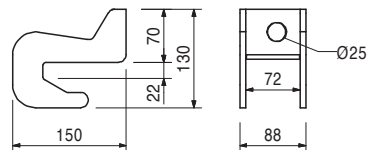
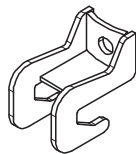

HD 200 Heavy-Duty Prop



Item no.	Weight kg
051410	11.700

Ladder 180/6, galv.
As access for PERI Formwork Systems.

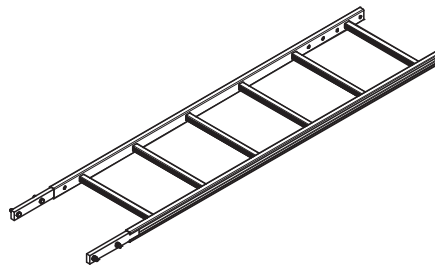

Complete with
4 pc. 710224 Bolt ISO 4017 M12 x 40-8.8, galv.
4 pc. 710381 Nut ISO 7042 M12-8, galv.

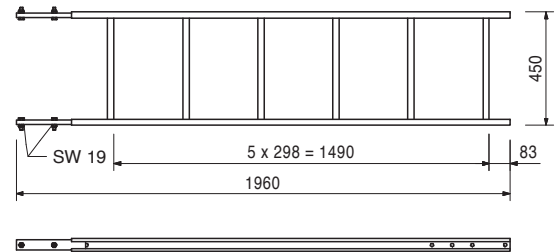

103718	0.684
--------	-------

Ladder Hook, galv.
For adjusting the bottom ladder.
Always use in pairs.



Complete with
2 pc. 710266 Bolt ISO 4017 M12 x 25-8.8, galv.
2 pc. 710381 Nut ISO 7042 M12-8, galv.

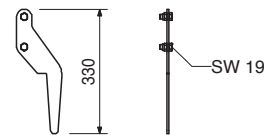

103724	10.400
--------	--------

End Ladder 180/2, galv.
As access for PERI Formwork Systems.

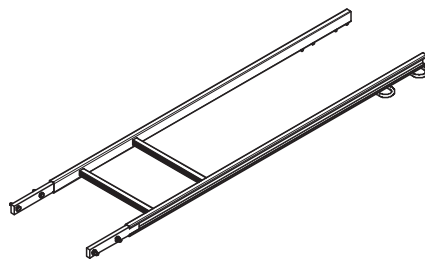

Complete with
4 pc. 710224 Bolt ISO 4017 M12 x 40-8.8, galv.
4 pc. 710381 Nut ISO 7042 M12-8, galv.

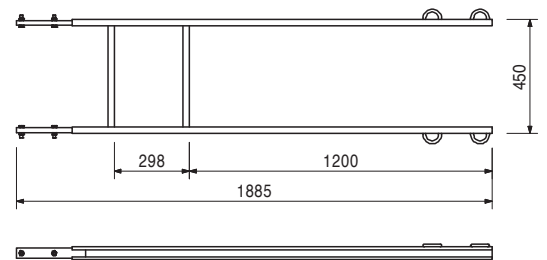

051460	2.180
--------	-------

Ladder Base, galv.
As bottom ladder connection and for securing ladders against sliding on the scaffold decks.

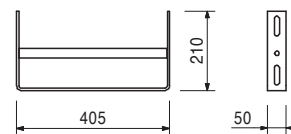
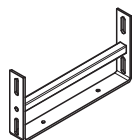

HD 200 Heavy-Duty Prop



Item no.	Weight kg
104646	4.220

Ladder Connector HD 200

For connecting ladders to HD 200 Prop Sections.

Complete with

2 pc. 701763 Clamping Plate FI 25 x 10 x 90
1 pc. 710266 Bolt ISO 4017 M12 x 25-8.8, galv.

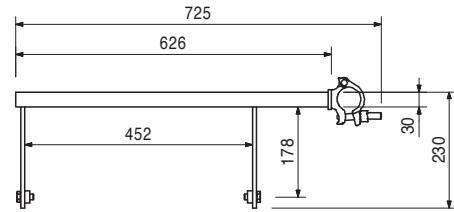
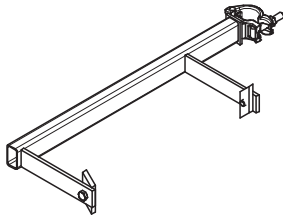

104132	15.600
051450	25.200

Ladder Safety Cages, galv.

Ladder Safety Cage 75, galv.

Ladder Safety Cage 150, galv.

Ladder safety cage for PERI Access Ladders.

Complete with

4 pc. 710266 Bolt ISO 4017 M12 x 25-8.8, galv.
4 pc. 701763 Clamping Plate FI 25 x 10 x 90

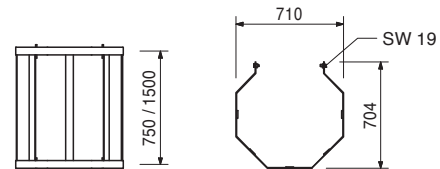
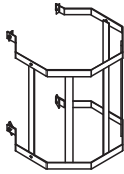

026415	3.550
026417	0.000
026411	3.550
026412	7.100
026413	10.650
026414	14.200
026419	17.750
026418	21.600

Scaffold Tubes Steel Ø 48.3 x 3.2

Scaff. Tube Steel Ø 48.3 x 3.2, special length

Cutting Cost Scaffold Tube

Scaff. Tube Steel Ø 48.3 x 3.2, l = 1.0 m

Scaff. Tube Steel Ø 48.3 x 3.2, l = 2.0 m

Scaff. Tube Steel Ø 48.3 x 3.2, l = 3.0 m

Scaff. Tube Steel Ø 48.3 x 3.2, l = 4.0 m

Scaff. Tube Steel Ø 48.3 x 3.2, l = 5.0 m

Scaff. Tube Steel Ø 48.3 x 3.2, l = 6.0 m

L

1000

2000

3000

4000

5000

6000

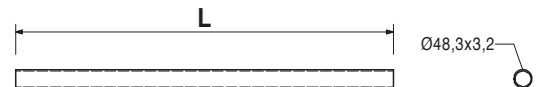
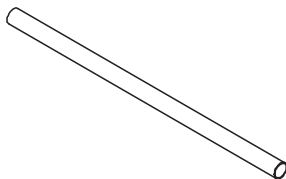

017020	1.120
--------	-------

Standard Coupler NK 48/48, galv.

For Scaffold Tubes Ø 48 mm.

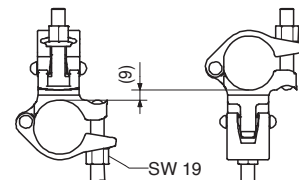
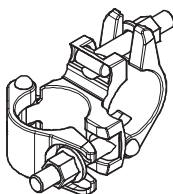

HD 200 Heavy-Duty Prop

Item no.	Weight kg
017010	1.400

Swivel Coupling DK 48/48, galv.
For Scaffold Tubes \varnothing 48 mm.

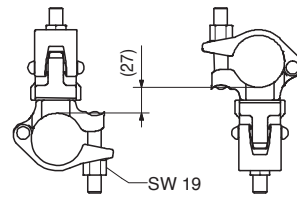
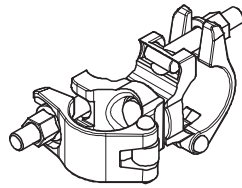

024590	32.000
--------	--------

Wedge Lowering Device 420 kN, painted
For releasing and lowering large loads.

Note

Take Type Test into consideration.
Wrench size SW 46.

Technical Data

Separate Design Information on request.

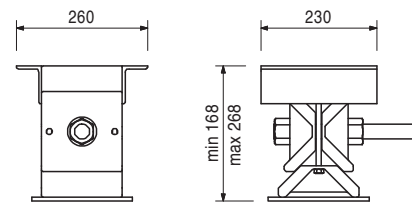
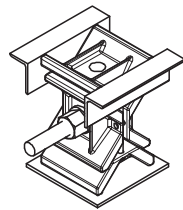

117930	53.300
--------	--------

Wedge Lowering Device 1000 kN, painted
For releasing and lowering large loads.

Note

Take Type Test into consideration.
Wrench size SW 46.

Technical Data

Separate Design Information on request.

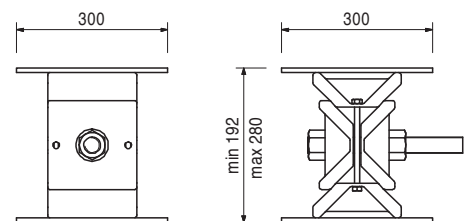
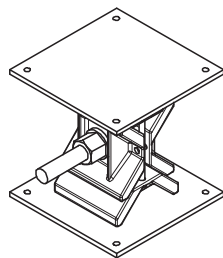

HD 200 Heavy-Duty Prop



Item no.	Weight kg
065066	15.100

End Guardrail Frame 55

Clampable end guardrail for all PERI Scaffold Platforms and Climbing Systems.

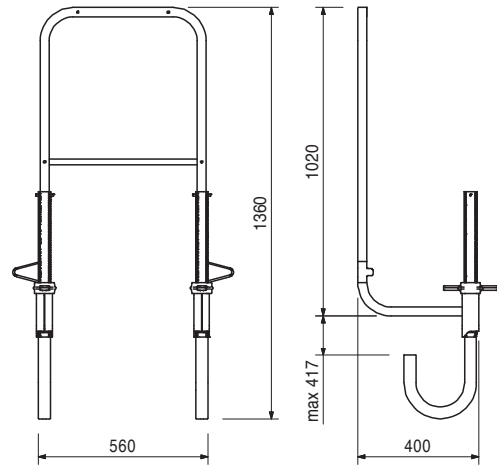
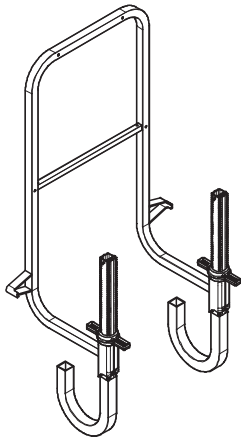

PERI International

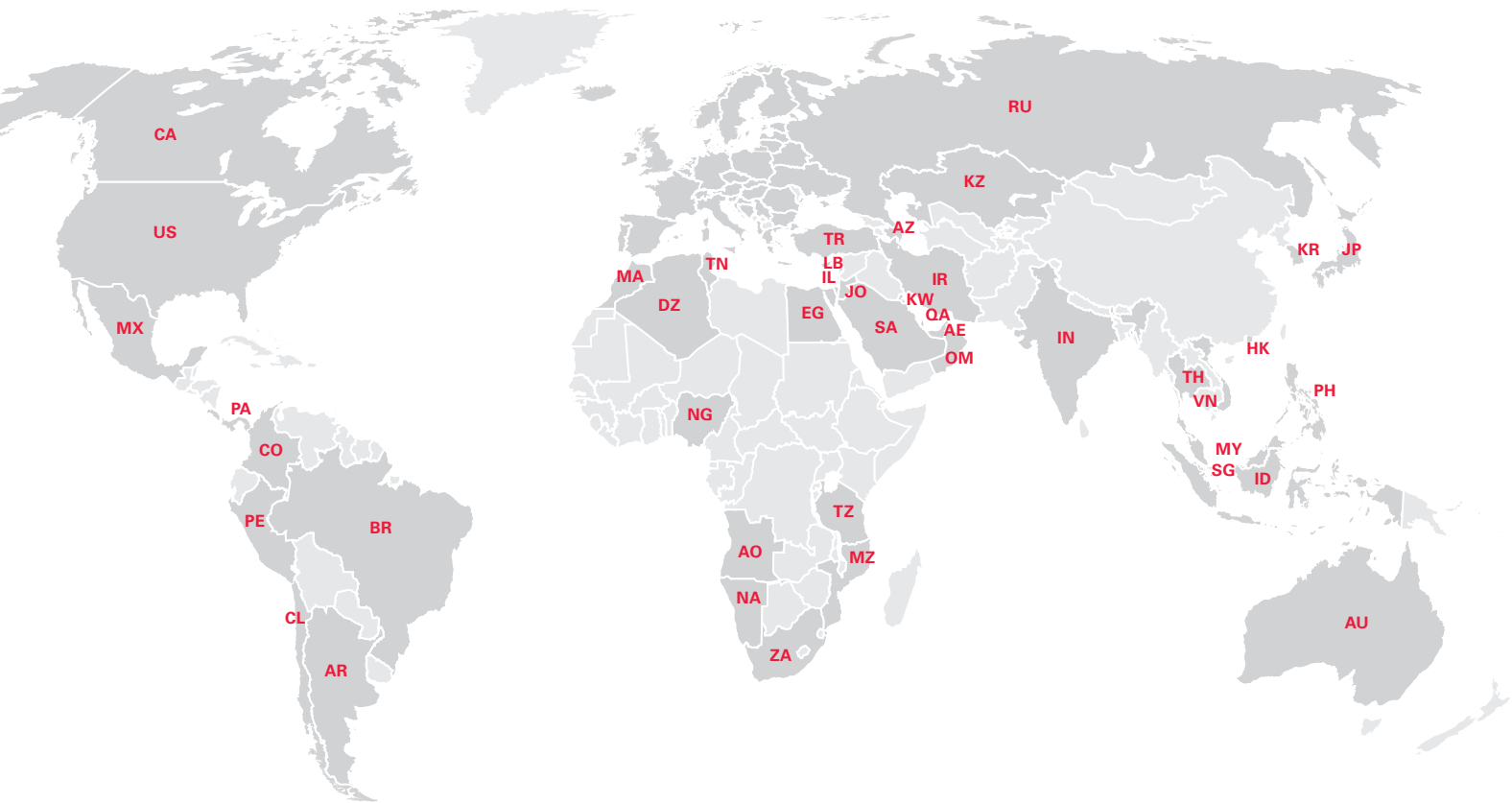

North America

- CA** Canada
PERI Formwork Systems, Inc.
www.peri.ca
- MX** Mexico
PERI Cimbras y Andamios, S.A. de C.V.
www.peri.com.mx
- PA** Panama
PERI Panama Inc.
www.peri.com.pa
- US** USA
PERI Formwork Systems, Inc.
www.peri-usa.com

South America

- AR** Argentina
PERI S.A.
www.peri.com.ar
- BR** Brazil
PERI Formas e Escoramentos Ltda.
www.peribrasil.com.br
- CL** Chile
PERI Chile Ltda.
www.peri.cl
- CO** Colombia
PERI S.A.S.
www.peri.com.co
- PE** Peru
PERI Peruana S.A.C.
www.peri.com.pe

Africa

- AO** Angola
Pericofragens, Lda.
www.peri.pt
- DZ** Algeria
S.A.R.L. PERI
www.peri.dz
- EG** Egypt
Egypt Branch Office
www.peri.com.eg
- MA** Morocco
PERI S.A.
www.peri.ma
- MZ** Mozambique
PERI (Pty.) Ltd.
www.peri.co.mz
- NA** Namibia
PERI (Pty.) Ltd.
www.peri.na
- NG** Nigeria
PERI Nigeria Ltd.
www.peri.ng
- TN** Tunisia
PERI S.A.U.
www.peri.es
- TZ** Tanzania
PERI Formwork and Scaffolding Ltd
www.peri.co.tz
- ZA** South Africa
PERI Formwork Scaffolding (Pty) Ltd
www.peri.co.za

Asia

- AE** United Arab Emirates
PERI (L.L.C.)
www.peri.ae
- AZ** Azerbaijan
PERI Representative Office
www.peri.com.tr
- HK** Hong Kong
PERI (Hong Kong) Limited
www.perihk.com
- ID** Indonesia
PT Beton Perkasa Wijaksana
www.betonperkasa.com
- IL** Israel
PERI F.E. Ltd.
www.peri.co.il
- IN** India
PERI (India) Pvt Ltd
www.peri.in
- IR** Iran
PERI Pars. Ltd.
www.peri.ir
- JO** Jordan
PERI GmbH – Jordan
www.peri.com
- JP** Japan
PERI Japan K.K.
www.peri.co.jp
- KR** Korea
PERI (Korea) Ltd.
www.perikorea.com
- KW** Kuwait
PERI Kuwait W.L.L.
www.peri.com.kw
- KZ** Kazakhstan
TOO PERI Kazakhstan
www.peri.kz
- LB** Lebanon
PERI Lebanon Sarl
lebanon@peri.de
- MY** Malaysia
PERI Formwork Malaysia Sdn. Bhd.
www.perimalaysia.com
- OM** Oman
PERI (L.L.C.)
www.peri.ae
- PH** Philippines
PERI-Asia Philippines, INC.
www.peri.com.ph
- QA** Qatar
PERI Qatar LLC
www.peri.qa
- SA** Saudi Arabia
PERI Saudi Arabia Ltd.
www.peri.com.sa
- SG** Singapore
PERI Asia Pte Ltd
www.periasia.com
- TH** Thailand
Peri (Thailand) Co., Ltd.
www.peri.co.th
- TR** Turkey
PERI Kalıp ve İskeleleri
www.peri.com.tr
- VN** Vietnam
PERI ASIA PTE LTD
www.peri.com.vn



PERI

**PERI GmbH
Formwork Scaffolding Engineering**

Rudolf-Diesel-Strasse 19
89264 Weissenhorn
Germany
Tel. +49 (0)7309.950-0
Fax +49 (0)7309.951-0
info@peri.com
www.peri.com

Oceania

AU Australia
PERI Australia Pty. Ltd.
www.periaus.com.au

DK Denmark
PERI Danmark A/S
www.peri.dk

IT Italy
PERI S.r.l.
www.peri.it

SE Sweden
PERI Sverige AB
www.peri.se

Europe

EE Estonia
PERI AS
www.peri.ee

LT Lithuania
PERI UAB
www.peri.lt

SI Slovenia
PERI oplate i skele d.o.o
www.peri.com.hr

AL Albania
PERI Kalıp ve İskeleleri
www.peri.com.tr

ES Spain
PERI S.A.U.
www.peri.es

LU Luxembourg
N.V. PERI S.A.
www.peri.lu

SK Slovakia
PERI spol. s. r.o.
www.peri.sk

AT Austria
PERI Ges.mbh
www.peri.at

FI Finland
PERI Suomi Ltd. Oy
www.perisuomi.fi

LV Latvia
PERI SIA
www.peri-latvija.lv

UA Ukraine
TOW PERI
www.peri.ua

BA Bosnia and Herzegovina
PERI oplate i skele d.o.o
www.peri.com.hr

FR France
PERI S.A.S.
www.peri.fr

NL Netherlands
PERI b.v.
www.peri.nl

BE Belgium
PERI N.V.
www.peri.be

GB United Kingdom
PERI Ltd.
www.peri.ltd.uk

NO Norway
PERI Norge AS
www.peri.no

BG Bulgaria
PERI Bulgaria EOOD
www.peri.bg

GR Greece
PERI Hellas Ltd.
www.perihellas.gr

PL Poland
PERI Polska Sp. z o.o.
www.peri.com.pl

BY Belorussia
IOOO PERI
www.peri.by

HR Croatia
PERI oplate i skele d.o.o.
www.peri.com.hr

PT Portugal
Pericofragens Lda.
www.peri.pt

CH Switzerland
PERI AG
www.peri.ch

HU Hungary
PERI Kft.
www.peri.hu

RO Romania
PERI România SRL
www.peri.ro

CZ Czech Republic
PERI spol. s r.o.
www.peri.cz

IR Ireland
Siteserv Access & Formwork
www.siteservaccess.ie

RS Serbia
PERI oplate d.o.o.
www.peri.rs

DE Germany
PERI GmbH
www.peri.de

IS Iceland
Armar ehf.
www.armor.is

RU Russia
OOO PERI
www.peri.ru

**The optimal System
for every Project and
every Requirement**



Wall Formwork



Column Formwork



Slab Formwork



Climbing Systems



Bridge Formwork

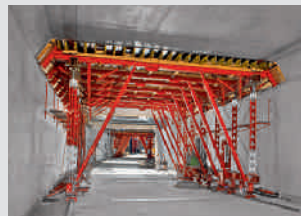

Tunnel Formwork



Shoring Systems



Construction Scaffold



Facade Scaffold



Industrial Scaffold



Access



Protection Scaffold



Safety Systems



System-Independent Accessories



Services



PERI GmbH
Formwork Scaffolding Engineering
 Rudolf-Diesel-Strasse 19
 89264 Weissenhorn
 Germany
 Tel. +49 (0)7309.950-0
 Fax +49 (0)7309.951-0
 info@peri.com
 www.peri.com