

RS Push-Pull Props

A programme with extension lengths up to 14 m



Edition 08 | 2015

PERI GmbH
Formwork Scaffolding Engineering

Rudolf-Diesel-Strasse 19
89264 Weissenhorn
Germany
Tel. +49 (0)7309.950-0
Fax +49 (0)7309.951-0
info@peri.com
www.peri.com

Important notes

All current safety regulations and guidelines must be observed in those countries where our products are used.

The photos shown in this brochure feature construction sites in progress. In addition, computer graphics are used which are to be understood as system representations. For this reason, safety and anchor details in particular cannot always be considered as conclusive or final. These are subject to the risk assessment carried out by the contractor.

For a better understanding, detailed illustrations are partly incomplete. The safety installations which have possibly not been shown in these detailed descriptions must nevertheless be available.

The systems or items shown might not be available in every country.

Safety instructions and load specifications are to be strictly observed at all times. Separate structural calculations are required for any deviations from the standard design data.

The information contained herein is subject to technical changes in the interests of progress. Errors and typographical mistakes reserved.

Content

- RS Push-Pull Props**
 - 3 A programme with extension lengths up to 14 m
- Safe and fast handling**
 - 4 from the assembly area
- Used also with prefabricated concrete elements**
 - 5 with Push-Pull Prop Adapter and Quick Connector
- RS Push-Pull Props in detail**
 - 6 Product overview and technical data
- Project examples**
 - 8 RS Push-Pull Props in use
- 10 RS Push-Pull Props components



RS Push-Pull Props

A programme with extension lengths up to 14 m

RS Push-Pull Props are used for the vertical alignment and transferring of wind loads from PERI Wall and Column Formwork as well as prefabricated concrete elements.

The PERI programme includes push-pull props with an extension length of up to 14 m. During its development, special emphasis was placed on ensuring fast and reliable handling, durability and low maintenance costs. For permanent protection against corrosion, both the tubes as well as the threads are completely galvanized.

RS Push-Pull Props are extendable. With the push-pull props in the PERI programme, formwork can be aligned for heights of up to 14 m. For standard applications up to a formwork height of 9 m, one row of push-pull props is sufficient.

PERI Push-Pull Props serve simultaneously as kicker braces. The provision of separate kickers is therefore unnecessary which, in turn, simplifies the logistics.

Fast and safe handling

Rough and fine adjustment for realizing the appropriate length take place safely within seconds from the installation area.

Used also with prefabricated concrete elements

Mounted from a safe position on the assembly area using Push-Pull Prop Adapters and Quick Connectors.

Durable

Galvanized tubes and threads for a long service life and low maintenance costs through hard-wearing corrosion protection.



Safe and fast handling from the assembly area



Fast

Rough adjustment of the push-pull prop in 10 cm increments is carried out by pulling in an outwards direction, and is realized very quickly. The fine adjustment then requires only a few turns of the push-pull prop.

Safe

The Push-Pull Props RS 210 to RS 450 as well as the RS 1400 can be adjusted from the assembly area regardless of the required extension length.

For the RS 1400, a chain allows attaching and releasing the crane slings without requiring a ladder.

For PERI Wall and Column Formwork

Matching accessories such as Push-Pull Prop Connectors, Head Pieces and Clamping Heads, allow the use of RS Push-Pull Props for both PERI Wall Formwork as well as PERI Column Formwork. Short push-pull props serve as kickers. These are connected to the same base plate as the push-pull prop and connected to the formwork using the designated accessory part.

The MXP Platform System, which is used with the MAXIMO and TRIO Wall Formwork Systems, has an integrated Push-Pull Prop Connector.



Easy and safe assembly of push-pull props and kickers on horizontally-positioned formwork, ...

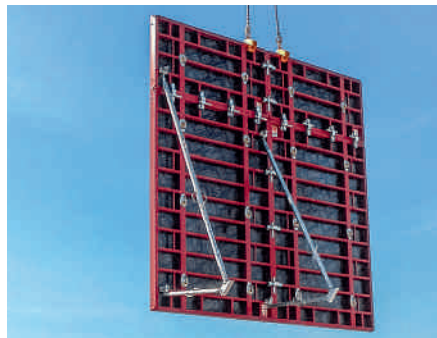

... moving the preassembled wall formwork units including push-pull props with the crane ...



... and installation at the required position.

Used also with prefabricated concrete elements **PERI** with Push-Pull Prop Adapter and Quick Connector

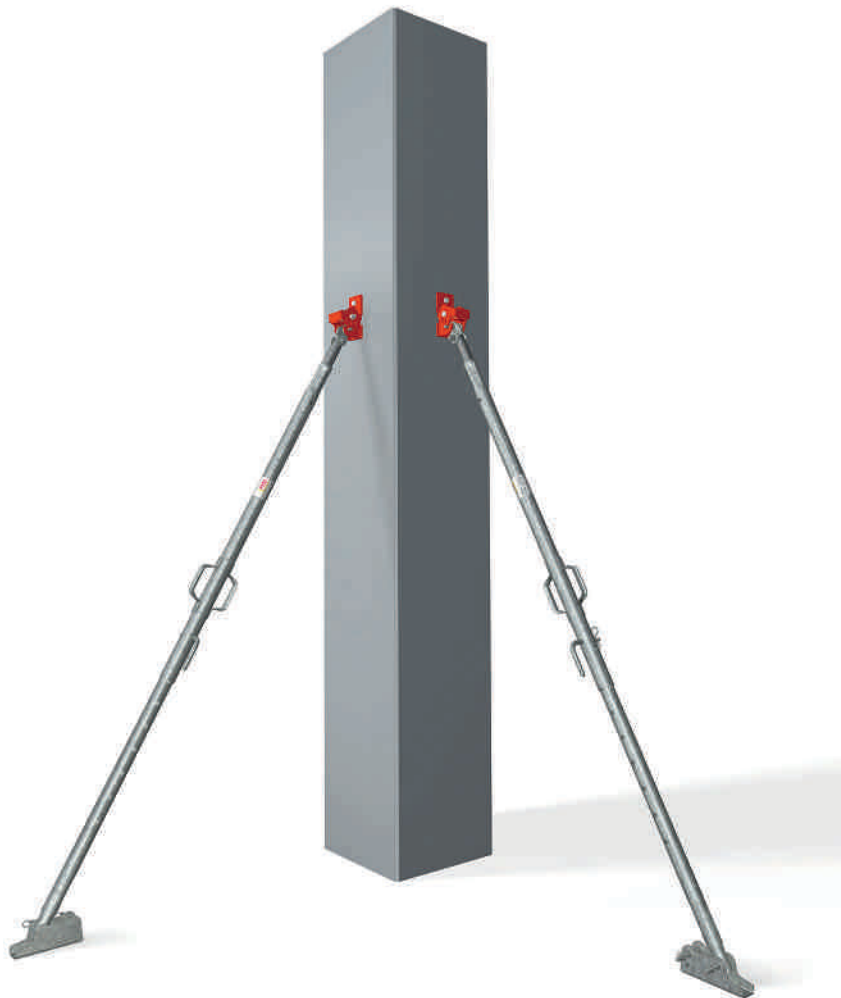

Supporting prefabricated components. For massive prefabricated components and hollow wall elements, the Push-Pull Prop Adapter RS and Quick Connector RS are used.

The complete assembly and dismantling of the push-pull props is carried out from the assembly area. Thus, the work is significantly safer and faster because ladders or working scaffold are not required.

Safe assembly

The Quick Connector RS is mounted on the horizontally-positioned prefabricated component, and the Push-Pull Prop Adapter to the push-pull prop.

The prefabricated component is positioned with the crane. When attaching the Push-Pull Prop Adapter to the Quick Connector, the securing lock is first pushed up and then it falls through its own weight and is secured in position. The push-pull prop remains securely fixed through tensile stress and pressure.

Fast dismantling

For dismantling the push-pull prop, the securing lock is simply pushed up with a board or a reinforcement bar and the push-pull prop is released.

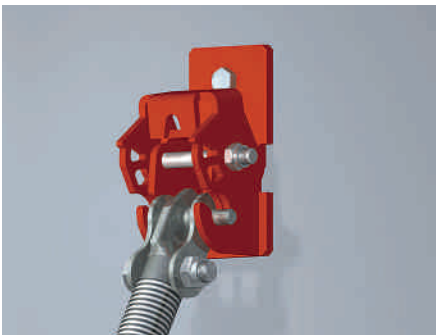

When attaching the Push-Pull Prop Adapter RS to the pre-assembled Quick Connector ...



... the securing lock of the Quick Connector is secured and fixes the push-pull prop in position.

RS Push-Pull Props in detail

Product overview and technical data

RS 210
L = 1.30 – 2.10 m

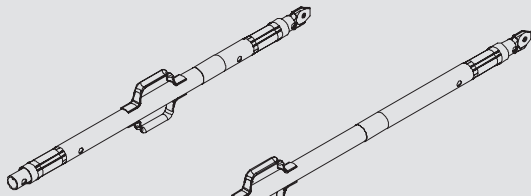

RS 260
L = 2.30 – 2.60 m

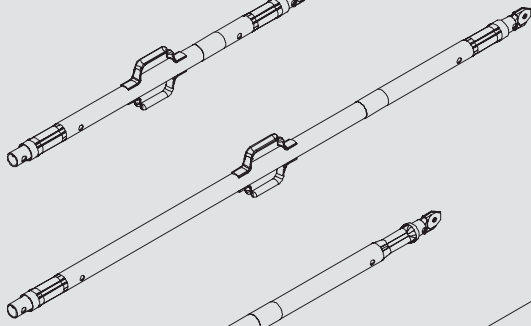

RS 300
L = 1.90 – 3.00 m

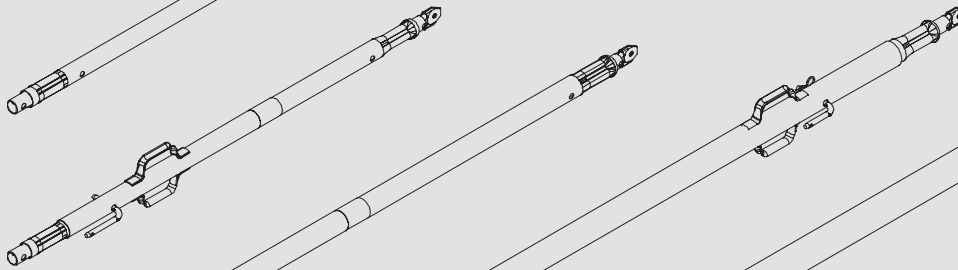

RS 450
L = 2.80 – 4.50 m

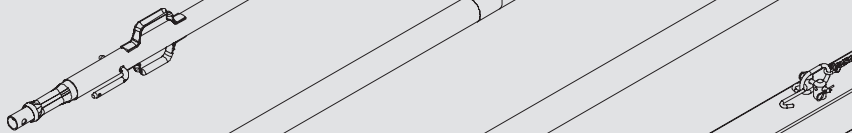

RS 650
L = 4.30 – 6.50 m

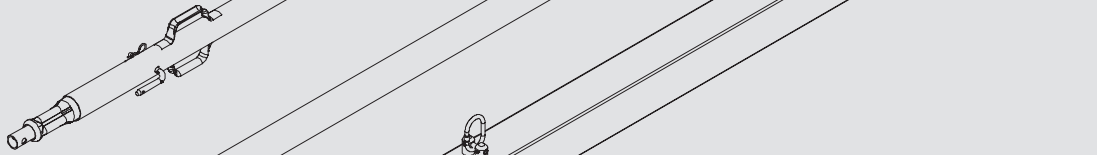

RS 1000
L = 6.40 – 10.00 m



RS 1400
L = 6.40 – 14.00 m

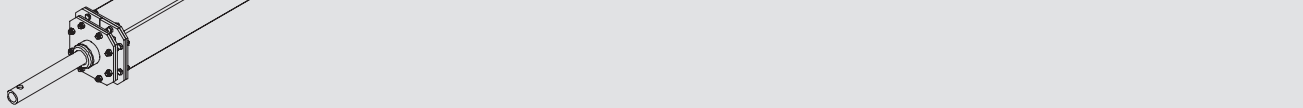

Head Pieces

For every PERI Wall and Column Formwork System, matching head pieces are available for the push-pull props. This is documented in the product overview at the end of this brochure.

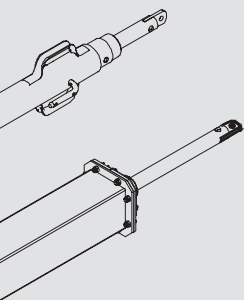

Push-Pull Prop RS 210 L = 1.30 – 2.10 m

Extension length [m]	1.30 – 2.00	2.10
Perm. compressive force F [kN]	25.0	23.6
Perm. tension force F [kN]	25.0	

Push-Pull Prop RS 260 L = 2.30 – 2.60 m

Extension length [m]	2.30	2.60
Perm. compressive force F [kN]	25.0	22.1
Perm. tension force F [kN]	25.0	

Push-Pull Prop RS 300 L = 1.90 – 3.00 m

Extension length [m]	1.90 – 2,30	2.50	3.00
Perm. compressive force F [kN]	25.0	21.6	14.2
Perm. tension force F [kN]	25.0		

Push-Pull Prop RS 450 L = 2.80 – 4.50 m

Extension length [m]	2.80 – 3,60	4.00	4.50
Perm. compressive force F [kN]	25.0	17.2	11.8
Perm. tension force F [kN]	25.0		

Push-Pull Prop RS 650 L = 4.30 – 6.50 m

Extension length [m]	4.30 – 4,90	5.00	5.50	6.00	6.50
Perm. compressive force F [kN]	25.0	24.4	18.5	15.9	13.2
Perm. tension force F [kN]	25.0				

Push-Pull Prop RS 1000 L = 6.40 – 10.00 m

Extension length [m]	6.40	7.00	8.00	9.00	10.00
Perm. compressive force F [kN]	29.5	26.0	19.6	14.6	11.1
Perm. tension force F [kN]	30.2				

Push-Pull Prop RS 1400 L = 6.40 – 14.00 m

Extension length [m]	6.40 – 11.00	12.00	13.00	14.00
Perm. compressive force F [kN]	30.9	28.6	23.4	19.1
Perm. tension force F [kN]	31.8			

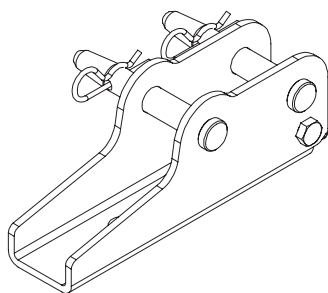

Base Plate-3 RS

Base Plate RS

All PERI Push-Pull Props are connected to the ground by means of the Base Plate-3 RS. The Base Plate is equipped with 2 bolts and thus additionally allows the connection of a shorter push-pull prop as kicker.

Project examples

RS Push-Pull Props in use



Use with VARIO GT 24 Girder Wall Formwork
Bridge piers, Velim railway testing facility of the VUZ
Research Institute, Czech Republic.

Use with VARIO GT 24 Girder Wall Formwork
The Arctic Ring, Copenhagen Zoo, Denmark.

Use with LICO Column Formwork
ITCC Phase II, Riyadh, Saudi Arabia.





The HELIOS building completed the INES complex, the National Institute for Solar Energy, in Le Bourget du Lac, France.

The 2.40 m wide and 13.50 m high movable units consisting of TRIO Panel Formwork were assembled on the ground and brought into position with the crane. Four rows of RS Push-Pull Props served to vertically position the formwork elements as well as transferring the wind loads. The props are connected to the Platform MXP which is tightly connected to the formwork thus facilitating safe working conditions at great heights.

Use with TRIO Wall Formwork

Bâtiment HELIOS pour l'INES, Le Bourget du Lac, France.

Use with MAXIMO Panel Formwork

CIMC Silvergreen production hall and administration building, Günzburg, Germany.



Use with TRIO Panel Formwork

Biomass storage facility, sugar factory Anklam, Germany.



Use with MAXIMO Formwork and MXP

Customer Service Centre, Winnenden, Germany.



RS and RSS Push-Pull Props



Item no.	Weight kg
117466	10.600

Push-Pull Prop RS 210, galv.

Extension length $l = 1.30 - 2.10$ m.
For aligning PERI formwork systems and precast concrete elements.

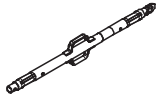

Note

Permissible load see PERI Design Tables.

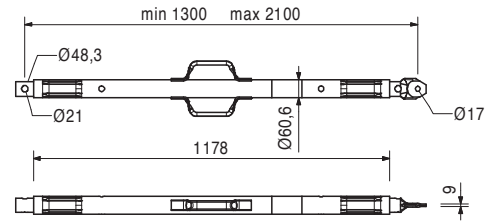

118238	12.200
--------	--------

Push-Pull Prop RS 260, galv.

Extension length $l = 2.30 - 2.60$ m.
For aligning PERI formwork systems and precast concrete elements.

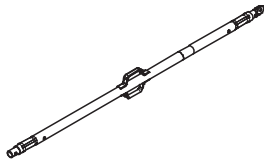

Note

Permissible load see PERI Design Tables.

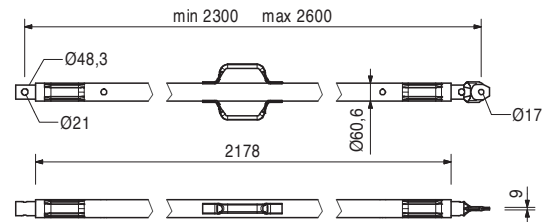

117467	15.500
--------	--------

Push-Pull Prop RS 300, galv.

Extension length $l = 1.90 - 3.00$ m.
For aligning PERI formwork systems and precast concrete elements.

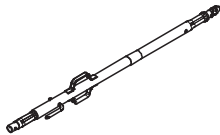

Note

Permissible load see PERI Design Tables.

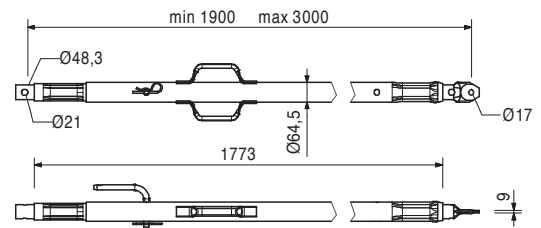

117468	23.000
--------	--------

Push-Pull Prop RS 450, galv.

Extension length $l = 2.80 - 4.50$ m.
For aligning PERI formwork systems and precast concrete elements.

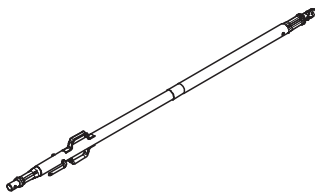

Note

Permissible load see PERI Design Tables.

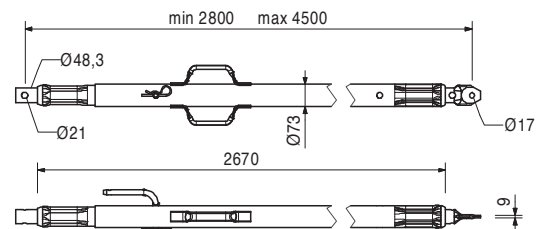

RS and RSS Push-Pull Props



Item no.	Weight kg
117469	40.000

Push-Pull Prop RS 650, galv.
 Extension length $l = 4.30 - 6.50$ m.
 For aligning PERI formwork systems and precast concrete elements.

Note
 Permissible load see PERI Design Tables.

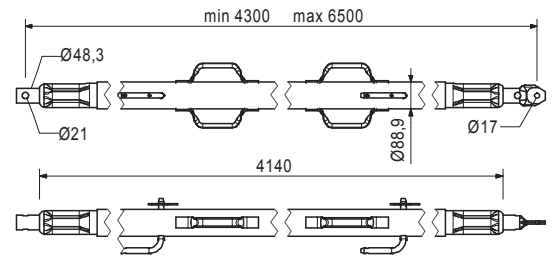
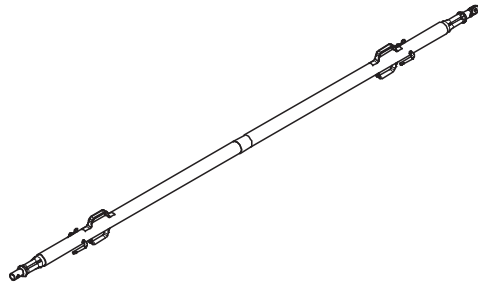

028990	115.000
--------	---------

Push-Pull Prop RS 1000, galv.
 Extension length $l = 6.40 - 10.00$ m.
 For aligning PERI formwork systems.

Note
 Permissible load see PERI Design Tables.

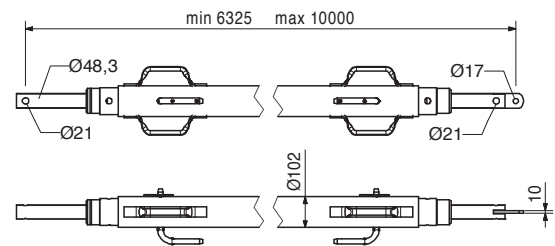
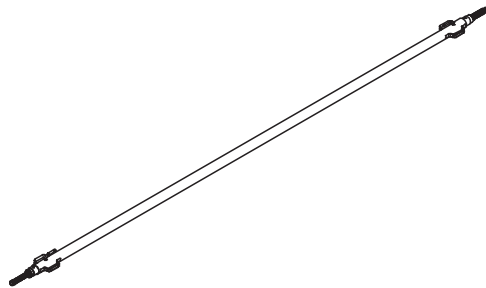

103800	271.000
--------	---------

Push-Pull Prop RS 1400, galv.
 Extension length $l = 6.40 - 14.00$ m.
 For aligning PERI formwork systems.

Note
 Permissible load see PERI Design Tables.
 Chain can be operated from bottom.

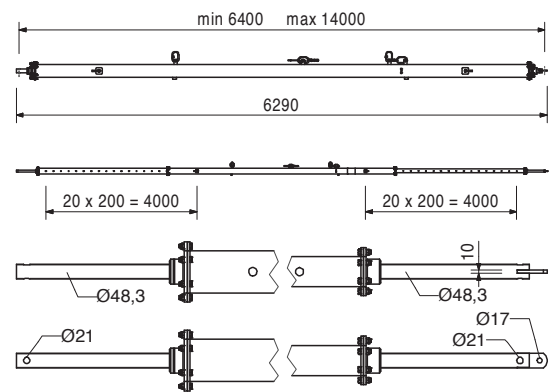
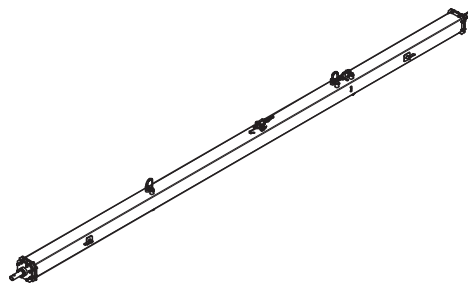

RS and RSS Push-Pull Props



Item no.	Weight kg
117343	3.250

Base Plate-2 for RS 210 – 1400, galv.
For assembly of Push-Pull Props RS 210, 260, 300, 450, 650, 1000 and 1400.

Complete with
2 pc. 105400 Pin Ø 20 x 140, galv.
2 pc. 018060 Cotter Pin 4/1, galv.

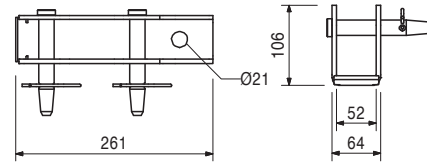
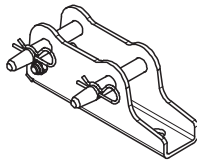

Accessories

124777	0.210
--------	-------

Anchor Bolt PERI 14/20 x 130

126666	3.070
--------	-------

Base Plate-3 for RS 210 - 1400
For assembly of Push-Pull Props RS 210, 260, 300, 450, 650, 1000 and 1400.

Complete with
2 pc. 105400 Pin Ø 20 x 140, galv.
2 pc. 018060 Cotter Pin 4/1, galv.
1 pc. 113063 Bolt ISO 4014 M12 x 80-8.8, galv.
1 pc. 113064 Hex Nut ISO7042-M12-8-G, galv.

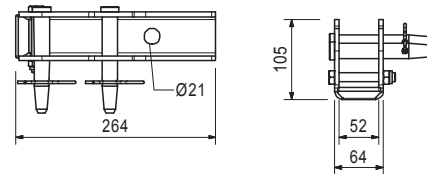
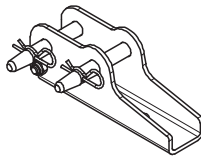

Accessories

124777	0.210
--------	-------

Anchor Bolt PERI 14/20 x 130

127190	4.190
--------	-------

Quick Assembly Head RS-2
For aligning precast concrete elements.

Complete with
1 pc. 105402 Bolt ISO 4014 M16 x 120-8.8, galv.
1 pc. 070890 Nut ISO 7042 M16-8, galv.

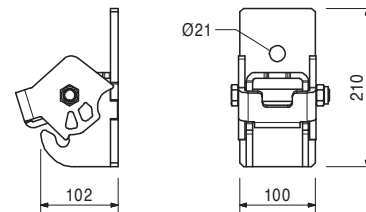
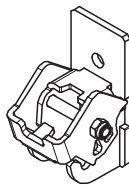

117470	4.260
--------	-------

Quick Connector Head RS
For aligning precast concrete elements.

Complete with
1 pc. 710232 Bolt ISO 4014 M16 x 130-8.8, galv.
1 pc. 070890 Nut ISO 7042 M16-8, galv.

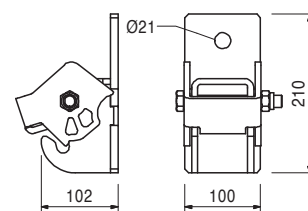
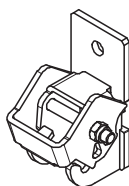

RS and RSS Push-Pull Props

Item no.	Weight kg
117726	1.050

Push-Pull Prop Adaptor RS
For aligning precast concrete elements.

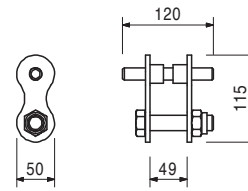
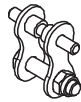

028010	17.900
--------	--------

Push-Pull Prop RSS I
Extension length $l = 2.05 - 2.94$ m.
For aligning PERI formwork systems.

Note
Permissible load see PERI Design Tables.

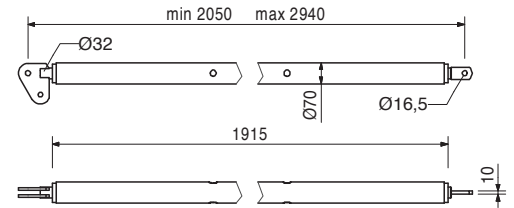
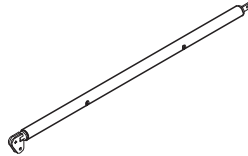

113397	1.600
--------	-------

Spindle Handle RSS / AV
Spindle Handle for screwing on Push-Pull-Props RSS I, RSS II, RSS III and Kickers AV 210 and AV 190 complete with 2 bolts and nuts M8.

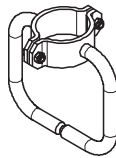
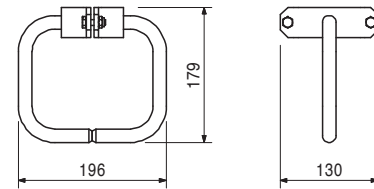

028020	22.000
--------	--------

Push-Pull Prop RSS II
Extension length $l = 2.91 - 3.80$ m.
For aligning PERI formwork systems.

Note
Permissible load see PERI Design Tables.

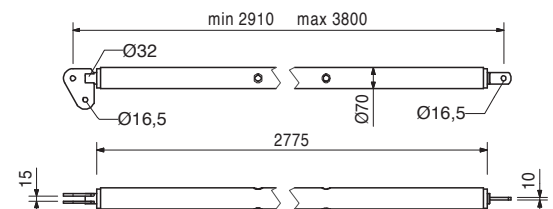
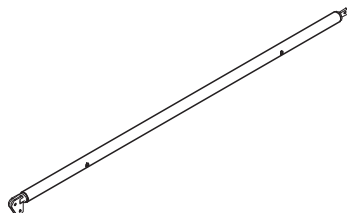

RS and RSS Push-Pull Props



Item no.	Weight kg
028030	38.400

Push-Pull Prop RSS III

Extension length l = 4.60 – 6.00 m.
For aligning PERI formwork systems.

Note

Permissible load see PERI Design Tables.

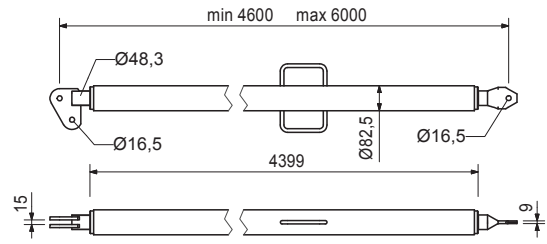
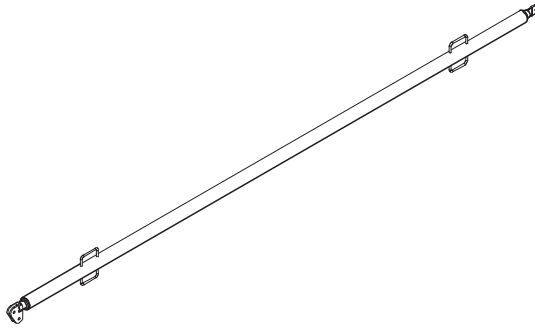

106000	1.820
--------	-------

Base Plate-2 for RSS, galv.

For assembly of RSS Push-Pull Props.

Complete with

1 pc. 027170 Pin Ø 16 x 42, galv.
1 pc. 018060 Cotter Pin 4/1, galv.

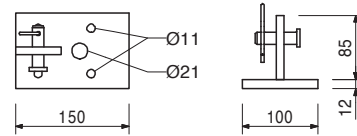
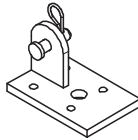

Accessories

124777	0.210
--------	-------

Anchor Bolt PERI 14/20 x 130

057087	3.720
057088	4.410

Kickers AV Kicker AV 82 Kicker AV 111

For aligning PERI formwork systems.

min. L	max. L
500	820
790	1110

Complete with

1 pc. 027170 Pin Ø 16 x 42, galv.
1 pc. 018060 Cotter Pin 4/1, galv.

Note

Permissible load see PERI Design Tables.

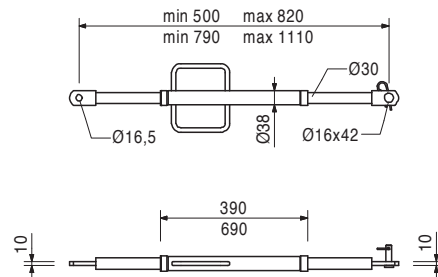
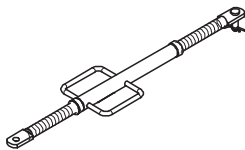

RS and RSS Push-Pull Props



Item no.	Weight kg
028110	5.180

Kicker AV 140

Extension length $l = 1.08 - 1.40$ m.
For aligning PERI formwork systems.

Complete with

1 pc. 027170 Pin $\varnothing 16 \times 42$, galv.
1 pc. 018060 Cotter Pin 4/1, galv.

Note

Permissible load see PERI Design Tables.

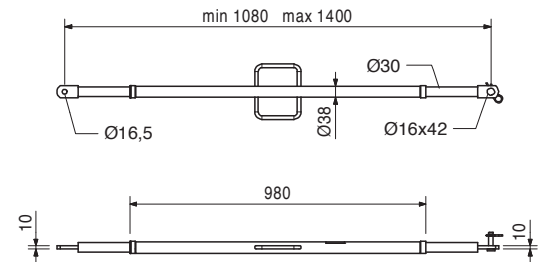
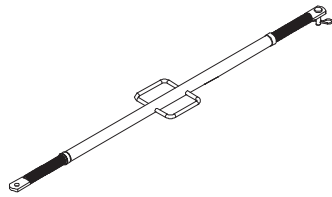

108135	12.900
--------	--------

Kicker AV 210

Extension length $l = 1.28 - 2.10$ m.
For aligning PERI formwork systems.

Complete with

1 pc. 027170 Pin $\varnothing 16 \times 42$, galv.
1 pc. 018060 Cotter Pin 4/1, galv.

Note

Permissible load see PERI Design Tables.

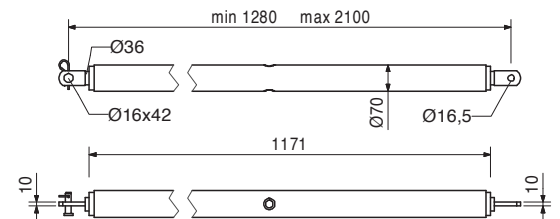
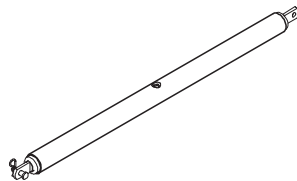

028120	17.000
--------	--------

Kicker AV RSS III

Extension length $l = 2.03 - 2.92$ m.
For aligning PERI formwork systems.

Complete with

1 pc. 027170 Pin $\varnothing 16 \times 42$, galv.
1 pc. 018060 Cotter Pin 4/1, galv.

Note

Permissible load see PERI Design Tables.

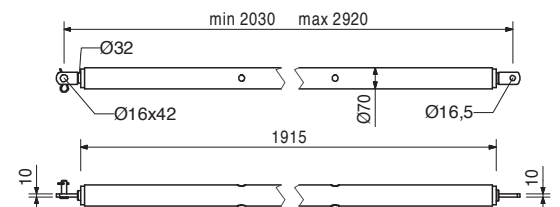
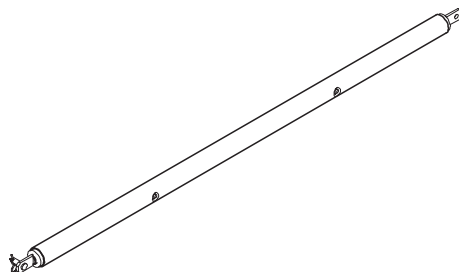

RS and RSS Push-Pull Props



Item no.	Weight kg
028050	4.550

Girder Headpiece GT 24, galv.

For connecting push-pull props and kicker braces to GT 24 Girders

Complete with

1 pc. 027170 Pin Ø 16 x 42, galv.
1 pc. 018060 Cotter Pin 4/1, galv.

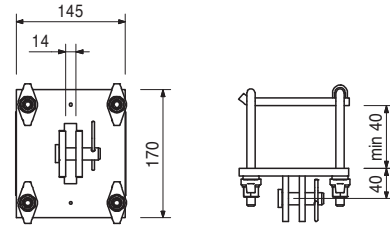
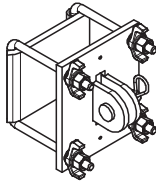

028070	4.680
--------	-------

Girder Headpiece GT 24/A, galv.

For connecting push-pull props and kicker braces to extended GT 24 Girders in the area of the Extension Splice 24-2.

Complete with

1 pc. 027170 Pin Ø 16 x 42, galv.
1 pc. 018060 Cotter Pin 4/1, galv.

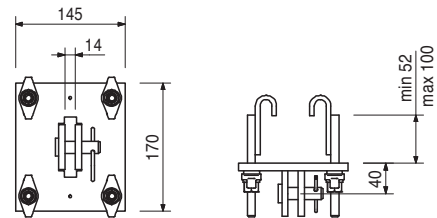
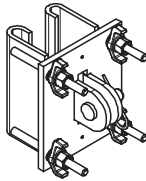

028060	1.940
--------	-------

Wedge Headpiece SRZ/SRU

For connecting push-pull props and kicker braces to Steel Waler SRZ and SRU Profile U100 – U140.

Complete with

1 pc. 027170 Pin Ø 16 x 42, galv.
1 pc. 018060 Cotter Pin 4/1, galv.

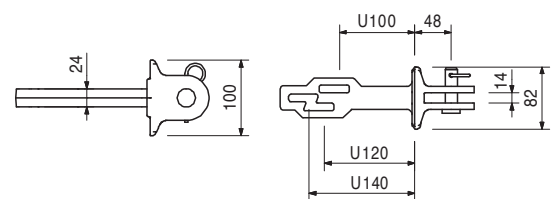
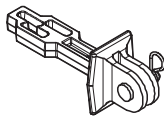

Accessories

024250	0.331
--------	-------

Wedge K, galv. (1 pc.)

024250	0.331
--------	-------

Wedge K, galv.

For coupling Compression Plate KDP, Wedge Head Piece SRZ/SRU and Waler Connector SB-A, B, C.

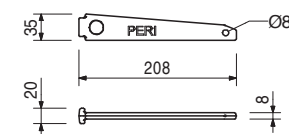

RS and RSS Push-Pull Props

Item no.	Weight kg
023660	3.300

Brace Connector TRIO, galv.

For connecting push-pull props and kicker braces to MAXIMO and TRIO Panels. Mounted on vertical and horizontal struts.

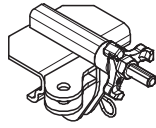

Complete with

- 1 pc. 027170 Pin Ø 16 x 42, galv.
- 1 pc. 018060 Cotter Pin 4/1, galv.

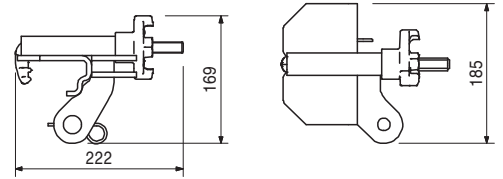

066082	1.040
--------	-------

Brace Connector DRA

For connecting push pull props and kicker braces at DOMINO panels.

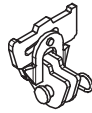

Complete with

- 1 pc. 027170 Pin Ø 16 x 42, galv.
- 1 pc. 018060 Cotter Pin 4/1, galv.

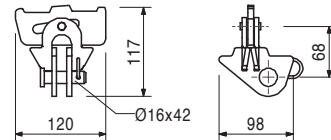

037190	3.010
--------	-------

Brace Connector-3 RAPID, galv.

For connecting push-pull props and kicker braces to the RAPID column frame.

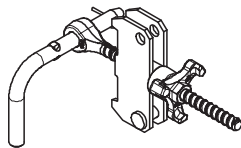

Complete with

- 1 pc. 037160 Bolt Ø 20 x 205, galv.
- 1 pc. 027170 Pin Ø 16 x 42, galv.
- 2 pc. 018060 Cotter Pin 4/1, galv.

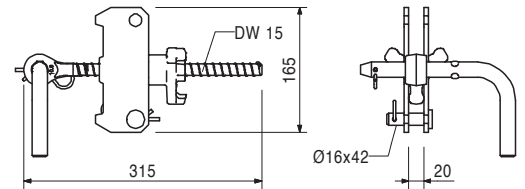

037530	1.130
--------	-------

Brace Connector QUATTRO QR

For connecting push-pull props and kicker braces to QUATTRO and LICO panels.



Complete with

- 1 pc. 027170 Pin Ø 16 x 42, galv.
- 1 pc. 018060 Cotter Pin 4/1, galv.

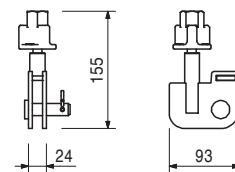

034550	1.130
--------	-------

Brace Connector HSRA

For connecting push-pull props and kicker braces to HANDSET panels.

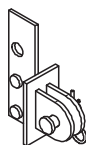

Complete with

- 1 pc. 027170 Pin Ø 16 x 42, galv.
- 1 pc. 018060 Cotter Pin 4/1, galv.

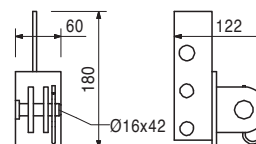

Item no.	Weight kg		
022016	1.290	Brace Connector HDR For connecting push-pull props and kicker braces to components Ø 48 mm.	Complete with 1 pc. 027170 Pin Ø 16 x 42, galv. 1 pc. 018060 Cotter Pin 4/1, galv.
117169	1.520	Brace Connector LIWA For connecting push-pull props and kicker braces to LIWA panels.	Complete with 1 pc. 027170 Pin Ø 16 x 42, galv. 1 pc. 105400 Pin Ø 20 x 140, galv. 2 pc. 018060 Cotter Pin 4/1, galv.
128294	0.909	Brace Connector DUO For connecting push-pull props and kicker braces to DUO panels.	Complete with 1 pc. 018050 Pin Ø 16 x 65/86, galv. 1 pc. 018060 Cotter Pin 4/1, galv.
028080	2.970	Connector Kicker/Push-Pull Prop, galv. For connecting push-pull props and kicker braces to Main Beam HDT.	Complete with 1 pc. 018060 Cotter Pin 4/1, galv. 1 pc. 027170 Pin Ø 16 x 42, galv.

RS and RSS Push-Pull Props

Item no.	Weight kg
027170	0.102

Pin Ø 16 x 42, galv.
For different connections.

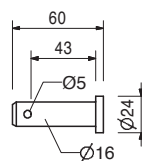

018060	0.030
--------	-------

Accessories
Cotter Pin 4/1, galv.

018050	0.171
--------	-------

Pin Ø 16 x 65/86, galv.
For different connections.

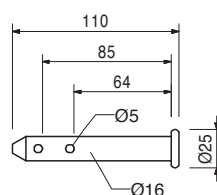
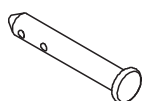

018060	0.030
--------	-------

Accessories
Cotter Pin 4/1, galv.

018060	0.030
--------	-------

Cotter Pin 4/1, galv.



124777	0.210
--------	-------

Anchor Bolt PERI 14/20 x 130
For temporary fixation to reinforced concrete structures.

Note
See PERI data sheet!
Drilling Ø 14 mm.

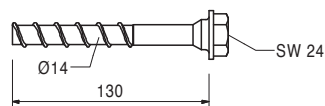
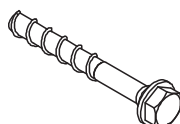

PERI International

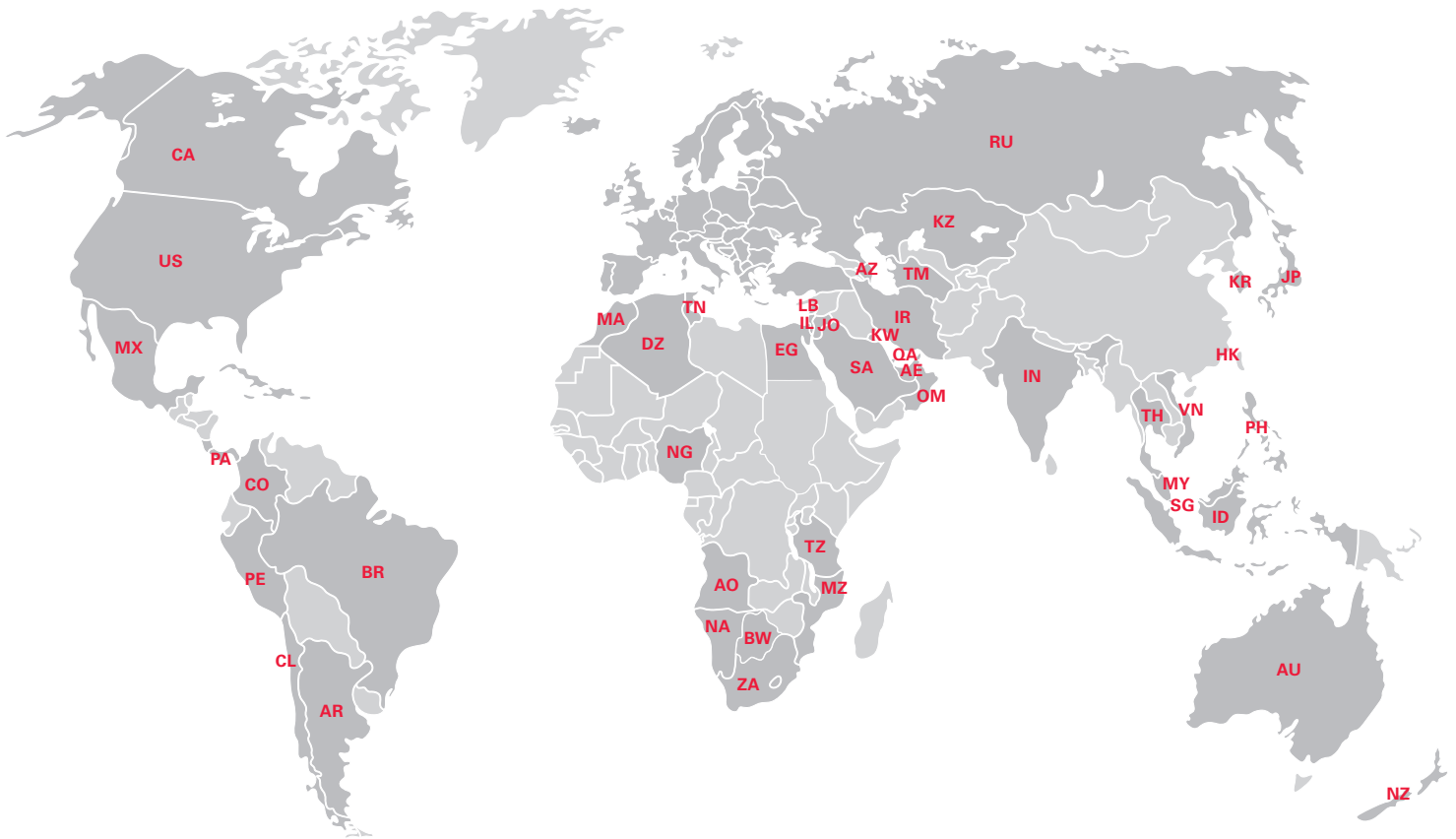

North America

- CA** Canada
PERI Formwork Systems, Inc.
www.peri.ca
- MX** Mexico
PERI Cimbras y Andamios, S.A. de C.V.
www.peri.com.mx
- PA** Panama
PERI Panama Inc.
www.peri.com.pa
- US** USA
PERI Formwork Systems, Inc.
www.peri-usa.com

South America

- AR** Argentina
PERI S.A.
www.peri.com.ar
- BR** Brazil
PERI Formas e Escoramentos Ltda.
www.peribrasil.com.br
- CL** Chile
PERI Chile Ltda.
www.peri.cl
- CO** Colombia
PERI S.A.S.
www.peri.com.co
- PE** Peru
PERI Peruana S.A.C.
www.peri.com.pe

Africa

- AO** Angola
Pericofragens, Lda.
www.peri.pt
- DZ** Algeria
S.A.R.L. PERI
www.peri.dz
- BW** Botswana
PERI (Proprietary) Limited
www.peri.co.bw
- EG** Egypt
Egypt Branch Office
www.peri.com.eg
- MA** Morocco
PERI S.A.
www.peri.ma
- MZ** Mozambique
PERI (Pty.) Ltd.
www.peri.co.mz
- NA** Namibia
PERI (Pty.) Ltd.
www.peri.na
- NG** Nigeria
PERI Nigeria Ltd.
www.peri.ng
- TN** Tunisia
PERI S.A.U.
www.peri.es
- TZ** Tanzania
PERI Formwork and Scaffolding Ltd
www.peritanzania.com
- ZA** South Africa
PERI Formwork Scaffolding (Pty) Ltd
www.peri.co.za

Asia

- AE** United Arab Emirates
PERI (L.L.C.)
www.perime.com
- AZ** Azerbaijan
PERI Representative Office
www.peri.com.tr
- HK** Hong Kong
PERI (Hong Kong) Limited
www.perihk.com
- ID** Indonesia
PT Beton Perkasa Wijaksana
www.betonperkasa.com
- IL** Israel
PERI F.E. Ltd.
www.peri.co.il
- IN** India
PERI (India) Pvt Ltd
www.peri.in
- IR** Iran
PERI Persa. Ltd.
www.peri.ir
- JO** Jordan
PERI GmbH – Jordan
www.peri.com
- JP** Japan
PERI Japan K.K.
www.perijapan.jp
- KR** Korea
PERI (Korea) Ltd.
www.perikorea.com
- KW** Kuwait
PERI Kuwait W.L.L.
www.peri.com.kw
- KZ** Kazakhstan
TOO PERI Kazakhstan
www.peri.kz
- LB** Lebanon
PERI Lebanon Sarl
lebanon@peri.de
- MY** Malaysia
PERI Formwork Malaysia Sdn. Bhd.
www.perimalaysia.com
- OM** Oman
PERI (L.L.C.)
www.perime.com
- PH** Philippines
PERI-Asia Philippines, INC.
www.peri.com.ph
- QA** Qatar
PERI Qatar LLC
www.peri.qa
- SA** Saudi Arabia
PERI Saudi Arabia Ltd.
www.peri.com.sa
- SG** Singapore
PERI Asia Pte Ltd
www.periasia.com
- TM** Turkmenistan
PERI Sanayi
www.peri.com.tr
- TH** Thailand
Peri (Thailand) Co., Ltd.
www.peri.co.th
- VN** Vietnam
PERI ASIA PTE LTD
www.peri.com.vn

PERI

PERI GmbH
Formwork Scaffolding Engineering
Rudolf-Diesel-Strasse 19
89264 Weissenhorn
Germany
Tel. +49 (0)7309.950-0
Fax +49 (0)7309.951-0
info@peri.com
www.peri.com



Oceania

AU Australia
PERI Australia Pty. Ltd.
www.periaus.com.au

NZ New Zealand
PERI Australia Pty. Limited
www.peri.co.nz

Europe

AL Albania
PERI Kalıp ve İskeleleri
www.peri.com.tr

AT Austria
PERI Ges.mbh
www.peri.at

BA Bosnia and Herzegovina
PERI oplate i skele d.o.o
www.peri.com.hr

BE Belgium
N.V. PERI S.A.
www.peri.be

BG Bulgaria
PERI Bulgaria EOOD
www.peri.bg

BY Belorussia
IOOO PERI
www.peri.by

CH Switzerland
PERI AG
www.peri.ch

CZ Czech Republic
PERI spol. S r.o.
www.peri.cz

DE Germany
PERI GmbH
www.peri.de

DK Denmark
PERI Danmark A/S
www.peri.dk

EE Estonia
PERI AS
www.peri.ee

ES Spain
PERI S.A.U.
www.peri.es

FI Finland
PERI Suomi Ltd. Oy
www.perisuomi.fi

FR France
PERI S.A.S.
www.peri.fr

GB United Kingdom
PERI Ltd.
www.peri.ltd.uk

GR Greece
PERI Hellas Ltd.
www.perihellas.gr

HR Croatia
PERI oplate i skele d.o.o.
www.peri.com.hr

HU Hungary
PERI Kft.
www.peri.hu

IR Ireland
Siteserv Access & Formwork
www.siteservaccess.ie

IS Iceland
Armar ehf.
www.armor.is

IT Italy
PERI S.p.A.
www.peri.it

LT Lithuania
PERI UAB
www.peri.lt

LU Luxembourg
N.V. PERI S.A.
www.peri.lu

LV Latvia
PERI SIA
www.peri-latvija.lv

NL Netherlands
PERI B.V.
www.peri.nl

NO Norway
PERI Norge AS
www.peri.no

PL Poland
PERI Polska Sp. z o.o.
www.peri.com.pl

PT Portugal
Pericofragens Lda.
www.peri.pt

RO Romania
PERI România SRL
www.peri.ro

RS Serbia
PERI oplate d.o.o.
www.peri.rs

RU Russia
OOO PERI
www.peri.ru

SE Sweden
PERI Sverige AB
www.periform.se

SI Slovenia
PERI oplate i skele d.o.o
www.peri.com.hr

SK Slovakia
PERI spol. s. r.o.
www.peri.sk

TR Turkey
PERI Sanayi ve Ticaret Ltd.
www.peri.com.tr

UA Ukraine
TOW PERI
www.peri.ua

**The optimal System
for every Project and
every Requirement**



Wall Formwork



Column Formwork



Slab Formwork



Climbing Systems



Bridge Formwork



Tunnel Formwork



Shoring Systems



Construction Scaffold



Facade Scaffold



Industrial Scaffold



Access



Protection Scaffold



Safety Systems



System-Independent Accessories



Services



PERI GmbH
Formwork Scaffolding Engineering
 Rudolf-Diesel-Strasse 19
 89264 Weissenhorn
 Germany
 Tel. +49 (0) 7309.950-0
 Fax +49 (0) 7309.951-0
 info@peri.com
 www.peri.com